

THE AURATM SKYLIGHT

Adding Natural Light to Your Home or Building

- Beautifies the room and is easy to install
- A clear polycarbonate roof lens and frosted ceiling lens allows maximum light entry and privacy
- Saves electricity by letting in natural light
- Fits all types of roofs and pitches
- Manufactured from spun aluminum and UV rated materials
- Durable and maintenance free
- Lifetime guarantee

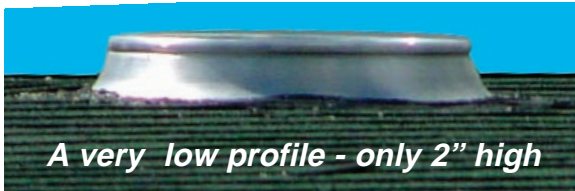
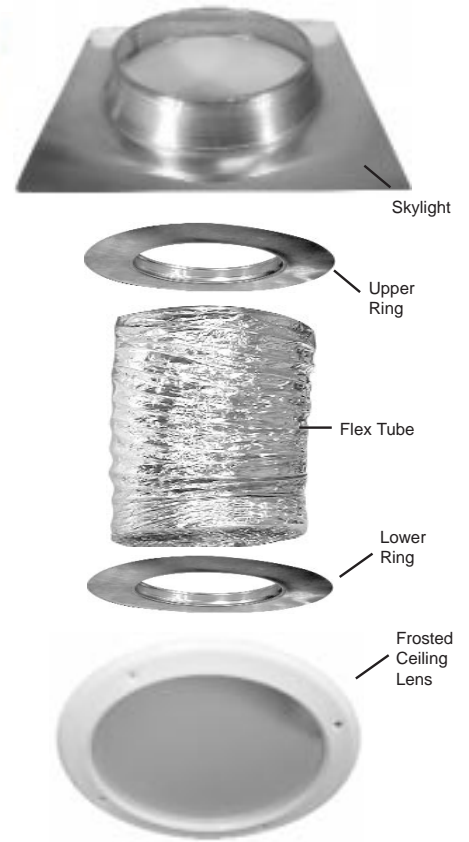

DATA SHEET AURA SKYLIGHT AS-10

as of March 1, 2003

Roof Lens

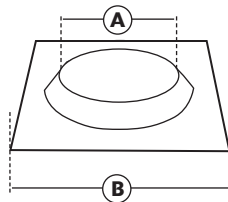

- A.** Diam. 10"
- B.** Width 16"
- C.** Height 2.5"

Flex Tube

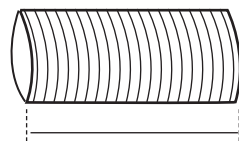

- 10" Diameter
- Std length is 3'
- other lengths available

Ceiling Lens

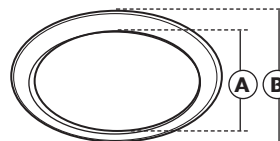

- A.** ID 9.5"
- B.** OD 12.75"
- C.** Thickness .75"

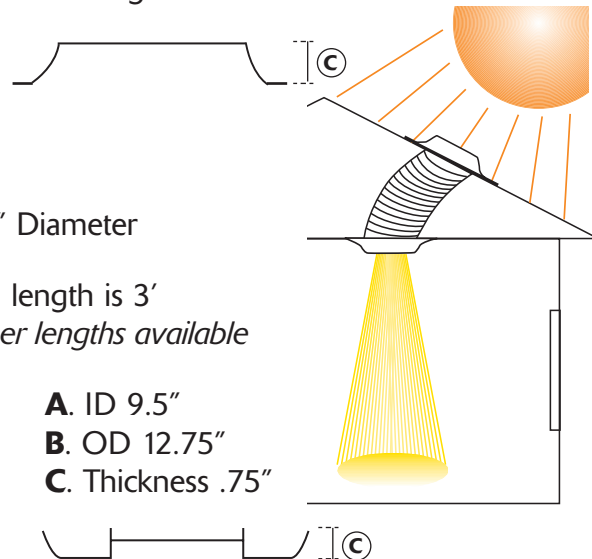

Weight of unit is 3 lbs.

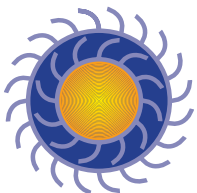

ACTIVE VENTILATION PRODUCTS, INC.

800-247-3463 845-565-7770

www.roofvents.com • E-mail: roofvents@aol.com • Fax 845-562-8963