

Round Back Roof Jack with Curb Mount Flange

Model Number: *RBV-7-C2-CMF-TP* | 7" Diameter 2" Tall Collar

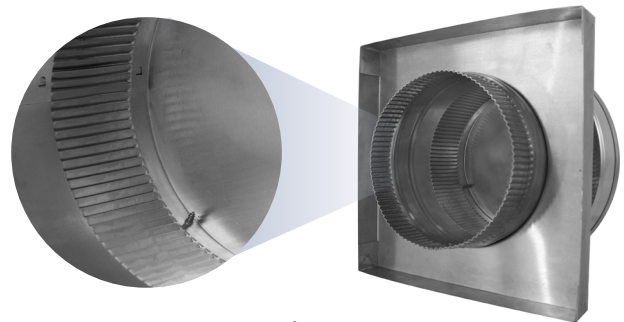

- The tailpipe adapter connects to ductwork to ventilate duct applications
- Curb Mount Flange fits over roof curbs for easy installation
- Engineered to prevent rain, snow and wildlife from entering
- Can be used as a hatch to service the attic or plenum
- Constructed of durable rust-free aluminum
- 5 Year Warranty

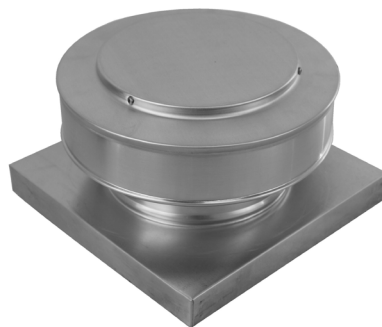

View of Inner Louvers

Dimensions & Specifications

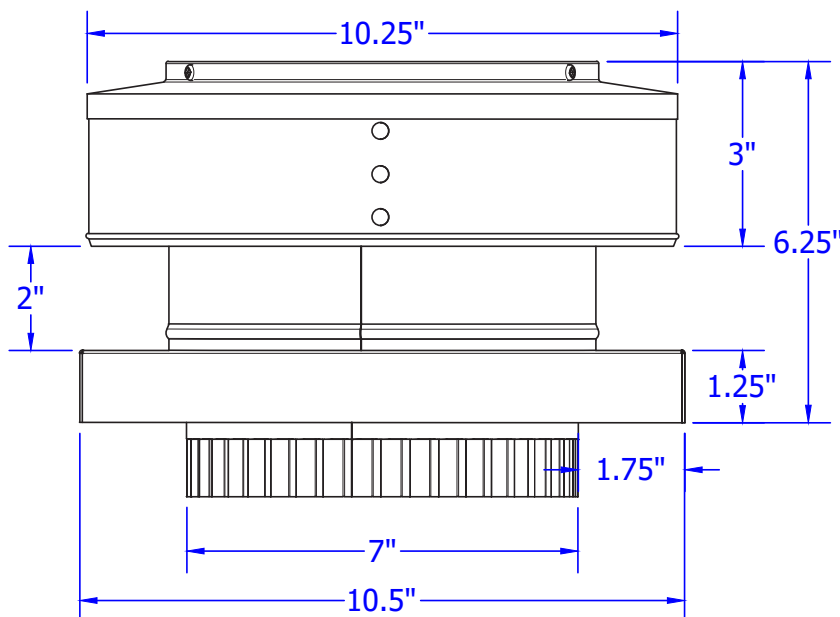

Net Free Vent Area	
(sq. inches)	(sq. feet)
38	0.26
Application per Sq. Foot	
(1/150)	(1/300)
79	158