

## For EPDM, PVC or TPO Membrane Flat Roofs

### Step 1:

Turn the vent upside down and make a cardboard template from the flange. The template should be the same size as the flange with the hole in the middle.

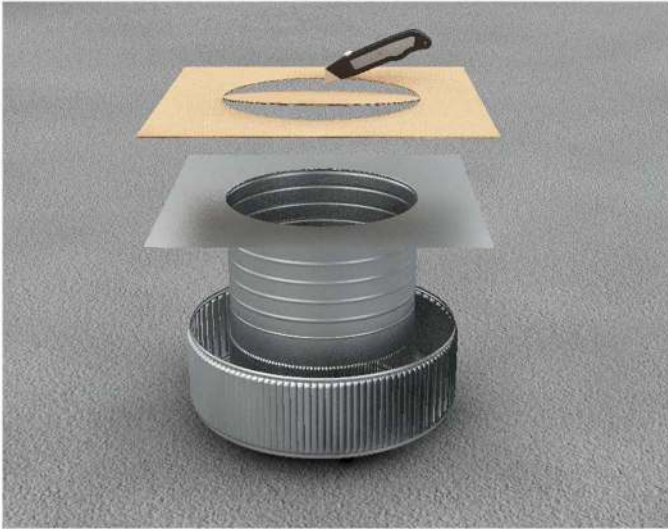

### Step 2:

Using the template, trace the square and circle onto the roof as shown.

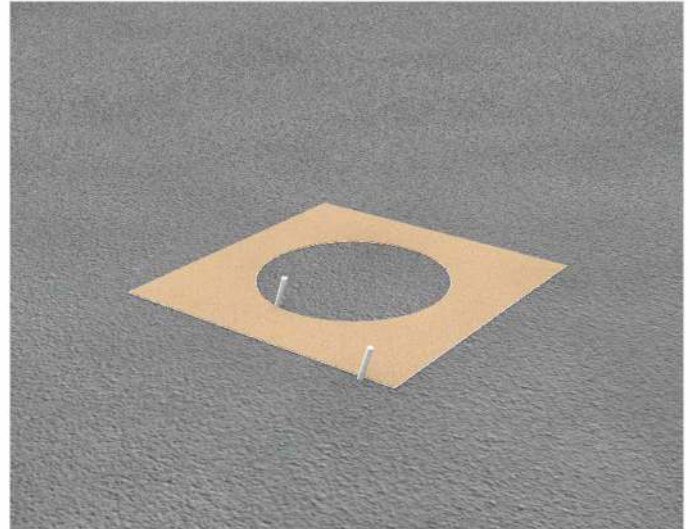

### Step 3:

Remove cardboard template to show the square and circle pattern.

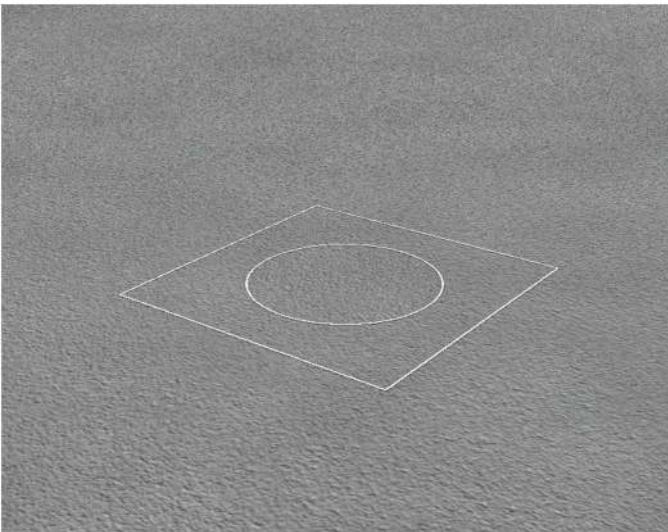

### Step 4:

With a razor blade, cut the circle traced out onto the membrane and remove. Then with a reciprocating saw, cut a hole in the roof deck and remove all debris.

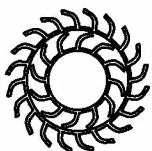
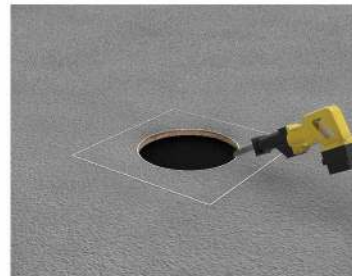

## Active Ventilation Products, Inc.

311 First Street, Newburgh, NY 12550-4857

800-ROOF VENT (766-3836) Ph: 845-565-7770 Fax: 845-562-8963

Website: [roofvents.com](http://roofvents.com) Email: [sales@roofvents.com](mailto:sales@roofvents.com)

5777-5

## For EPDM, PVC or TPO Membrane Flat Roofs

### Step 5:

Apply sealant within the square flange outline.



### Step 6A:

Place vent within the square outline & attach using a screw gun or drill.



### 6B:

Required Screw: #10 x 1.5" steel sheet metal screw  
Total number of screws required = 12 (tolerance : 1/2")

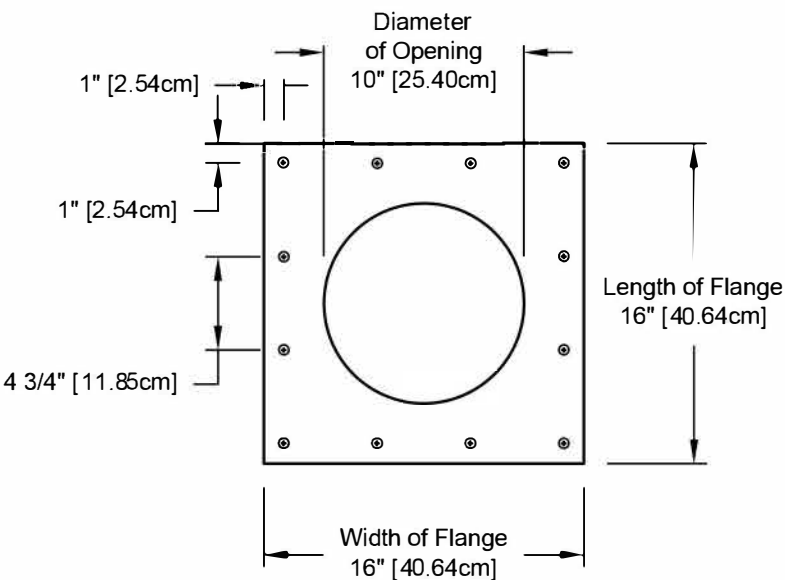

### Step 7:

Apply roofing cement over the screws and edge of flange. This is how the Aura vent should look when finished.

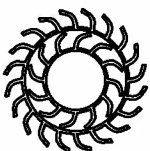
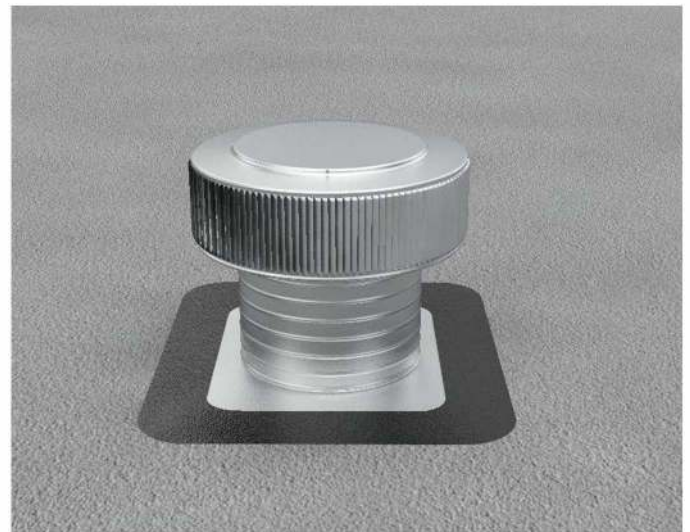

## Active Ventilation Products, Inc.

311 First Street, Newburgh, NY 12550-4857

800-ROOF VENT (766-3836) Ph: 845-565-7770 Fax: 845-562-8963

Website: [roofvents.com](http://roofvents.com) Email: [sales@roofvents.com](mailto:sales@roofvents.com)

5777-5