

Step 1:

Turn the vent upside down and make a cardboard template from the flange. The template should be the same size as the flange with the hole in the middle.



Step 2:

Using the template, trace the square and circle onto the roof as shown.

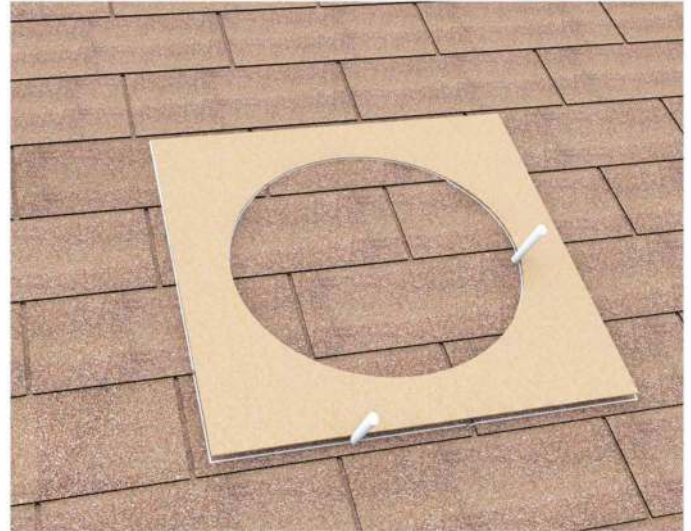

Step 3:

Remove cardboard template to show the square and circle pattern.



Step 4:

Using a reciprocating saw cut out a hole in the roof deck and remove all debris.



Step 5:

Put roofing sealant on the underside along the bottom edge of flange as shown.

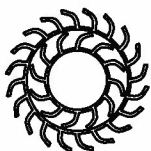

Active Ventilation Products, Inc.

311 First Street, Newburgh, NY 12550-4857

800-ROOF VENT (766-3836) Ph: 845-565-7770 Fax: 845-562-8963

Website: roofvents.com Email: sales@roofvents.com

5777-4

Step 6:

Slide vent underneath the shingles, stay within the square outline.



Step 7A:

With the vent in place secure the flange to the shingle roof using a screw gun or drill



7B:

Required Screw: #10 x 1.5" steel sheet metal screw
Total number of screws required = 16 (tolerance :1/2")

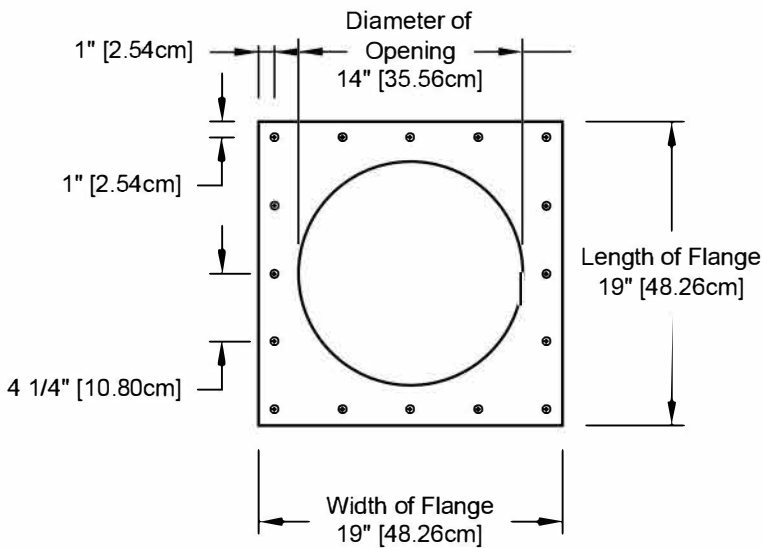

Step 8:

This is how the Aura Vent should look when finished

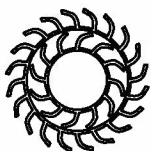

Active Ventilation Products, Inc.

311 First Street, Newburgh, NY 12550-4857

800-ROOF VENT (766-3836) Ph: 845-565-7770 Fax: 845-562-8963

Website: roofvents.com Email: sales@roofvents.com

5777-4