

# Installation Instructions for AV-18-C6-CMF

For EPDM, PVC or TPO Membrane Flat Roofs

## Step 1:

For Roof Curb Installation see [roofvents.com](http://roofvents.com)



## Step 2:

Slide the Curb Mount Flange onto the roof curb.  
Attach Curb Mount Flange to roof curb.

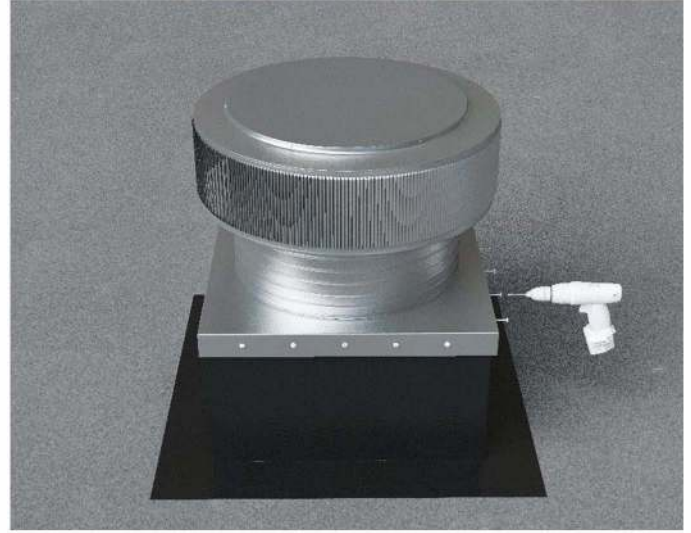

## Step 3:

Required Screw: #8 x1/2" hex washer head #2 point self drilling screw.

Total number of screws required = 20 (tolerance : 1/2")  
see [roofvents.com](http://roofvents.com) for a more detailed installation pattern.

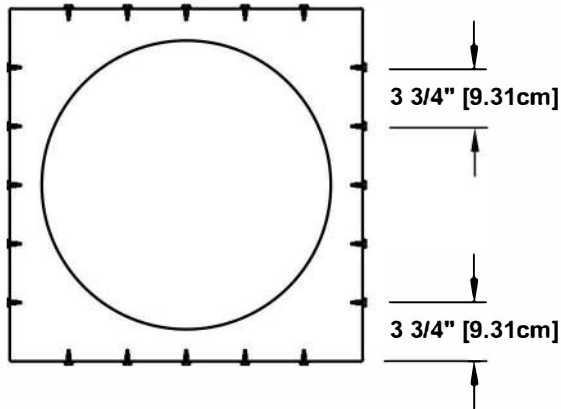

Roof Vent with Curb Mount Flange accessory  
installed onto roof curb.

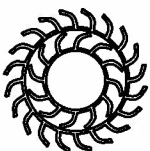
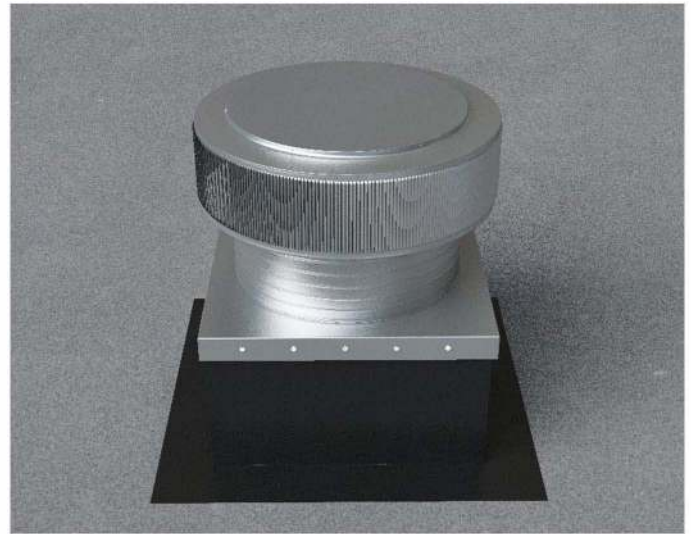

## Active Ventilation Products, Inc.

311 First Street, Newburgh, NY 12550-4857

800-ROOF VENT (766-3836) Ph: 845-565-7770 Fax: 845-562-8963

Website: [roofvents.com](http://roofvents.com) Email: [sales@roofvents.com](mailto:sales@roofvents.com)

5778-7