

Curb Mount Flange Installation Detail

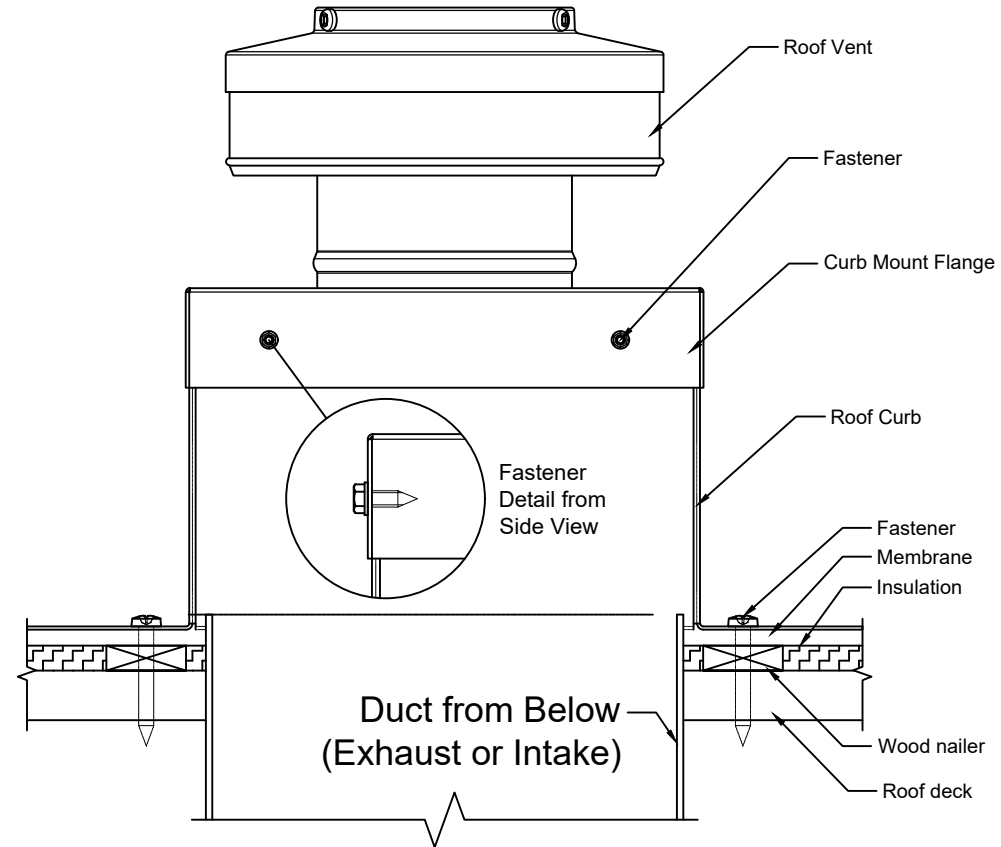

Curb Mount Flange Installation Instructions

1. Slide Curb Mount Flange onto the Roof Curb.
2. Attach Curb Mount Flange to Roof Curb using screws.
3. *Recommended installation screw: Flat, Bugle or Wafer Head #10 x 1/2" Sheet Metal Screw, Type A Point*
4. Total number of screws needed for CMF = 8 (*screws not included*)

Keepa Attic Vent with Curb Mount Flange

Model: KV-4-CMF

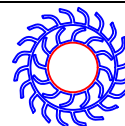

Active Ventilation Products, Inc.

Website: roofvents.com

Email: sales@roofvents.com

9/1/2023