

# Active Ventilation Products

Newburgh, NY • roofvents.com

845-565-7770 • sales@roofvents.com



## Roof Accessories 07 72 00

### Keepa Vent 3-Part Spec – Model: KV-6



Active Ventilation Products' Keepa Vent is used to ventilate flat and low-pitch roofs. The Keepa Vent is a two-way roof vent, meaning it brings fresh, dry air into the attic and exhausts out the hot, stale air. Doing this also makes the building more energy efficient and will add years of life to the roof. The Keepa Vent will last the roof's life even in corrosive-prone oceanfront areas. Built to be high profile, the Keepa Vent is engineered to work properly even when flat roofs experience a snowpack. The Keepa's round aerodynamic design will withstand harsh weather and handle wind pressure over 200 mph. The installation of the Keepa Vent is easy to do because its head is removable, making it user-friendly for roof inspections.

Miami-Dade County Approved & UL Listed, The Keepa Vent is proudly designed, and fabricated, and assembled in the U.S.A.

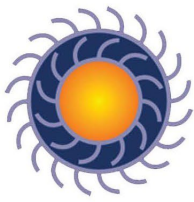

# Active Ventilation Products

Newburgh, NY • [roofvents.com](http://roofvents.com)

845-565-7770 • [sales@roofvents.com](mailto:sales@roofvents.com)



This guide is written under the Construction Specifications Institute (CSI) 3-Part Specification using *CSI MasterFormat 2020 Edition*. All section numbers and titles are based on *MasterFormat 2020 Edition*.

**The CSI Master number classification for this product's division, subsection number, and titles are the following:**

07 00 00 Division: Thermal and Moisture Protection:

07 72 00 Section: Roof Accessories

07 72 23 Title: Relief Vent (Roof Vent)

**Company Bio:** Active Ventilation Products, Inc. (AVP) was founded in 1997 and is an innovative sheet metal fabrication facility located in Newburgh, NY. AVP produces high-quality spun aluminum roof vents, commercial roof exhaust fans, residential attic fans, solar attic fans, roof curbs, and roof accessories. Roof Vents range in size from 3 inches in diameter to 48 inches. Collar heights range from 1 inch to 12 inches.

Headquartered in the Hudson Valley of New York, AVP is housed in a 63,000-square-foot building with over 50 sheet metal fabricators on staff.

The management of Active Ventilation Products is committed to providing high-quality products and services that meet or exceed the customers' expectations. It is believed that quality is a result of the process involving continuous improvement, innovation, and learning.

Active Ventilation Products, Inc., is located at

311 1<sup>st</sup> Street, Newburgh, NY 12550

(845) 565-7770

[www.roofvents.com](http://www.roofvents.com)

[sales@roofvents.com](mailto:sales@roofvents.com)

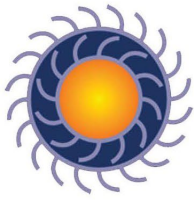

# Active Ventilation Products

Newburgh, NY • roofvents.com

845-565-7770 • sales@roofvents.com



## PART 1 General

### 1.1 Summary

#### A. Section Includes:

1. Keepa Vent, KV-6 - best used for flat roof or low-pitch roof attic spaces as an exhaust or fresh air intake roof vent.

#### B. Related Documents

1. Section 07 50 00 – Membrane Roofing
2. Section 07 60 00 – Flashing and Sheet Metal
3. Section 07 70 00 – Roof and Wall Specialties and Accessories
4. Section 07 72 00 – Roof Accessories
5. Section 07 92 00 – Joint Sealants

### 1.2 Reference Standards

#### A. Material Testing Standards:

1. Aluminum Standards:
  - a. ASTM B 209/B 209M – Specification for Aluminum and Aluminum-Alloy Sheet and Plate
2. Fastener Standards:
  - a. ASTM F593 – (National) Standard Specification for Stainless Steel Bolts, Hex Cap Screws, and Studs

#### B. Test Methods:

1. ASTM E330 – (National) Standard Test Method for Structural Performance of Exterior Windows, Doors, Skylights and Curtain Walls by Uniform Static Air Pressure Difference
  - a. ASTM E1886 – (National) Standard Test Method for Performance of Exterior Windows, Curtain Walls, Doors, and Impact Protective Systems Impacted by Missile(s) and Exposed to Cyclic Pressure Differentials
2. TAS 202 – (State of Florida) Criteria for Testing Impact & Non-impact Resistant Building Envelope Components Using Uniform Static Air Pressure

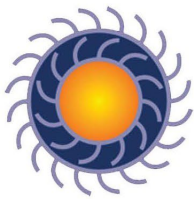

# Active Ventilation Products

Newburgh, NY • [roofvents.com](http://roofvents.com)

845-565-7770 • [sales@roofvents.com](mailto:sales@roofvents.com)



3. TAS 100(a) – (Miami-Dade County) Standard Test Procedure for Wind and Wind Driven Rain Resistance and/or Increased Windspeed Resistance of Soffit Ventilation Strip and Continuous or Intermittent Ventilation System Installed at the Ridge Area
4. FBC (HVHZ) – Florida Building Code (High-Velocity Hurricane Zones), Regulated by Chapter 31 of the Florida Building Code – Residential.

## C. Certifications

1. Miami-Dade County, Florida Notice of Acceptance (NOA) – FBC (HVHZ), TAS 100(a):
  - a. NOA# 22-0722.08
2. Florida Building Code 2017 – ASTM E330 & TAS 202:
  - a. Certificate of Product Approval # is #FL4763-R1
    - i. Tested to design pressure of 68 psf  $\approx$  (163 MPH winds)
3. Underwriters Laboratory (UL):
  - a. Certificate Number: 20170509-R38772

## 1.3 Submittals

A. Product Data: Active Ventilation Products, Inc. standard specifications and descriptive literature including:

1. Technical Specification product sheet, in PDF located at [roofvents.com/drawings](http://roofvents.com/drawings)
2. Technical Specification product sheet, in CAD located at [roofvents.com/drawings](http://roofvents.com/drawings)
3. Technical Specification product sheet, in BIM located at [roofvents.com/drawings](http://roofvents.com/drawings)

### Keepa Attic Vent - Technical Drawing Downloads

[Product Link](#)   [Drawing - Unmarked dwg](#)   [Drawing - Cut Away and Dimensioned](#)   [Revit Model](#)

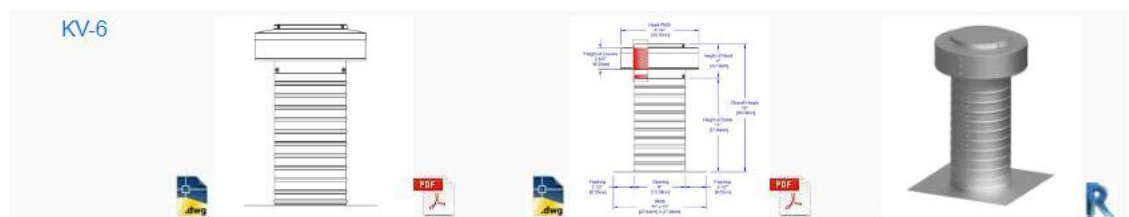

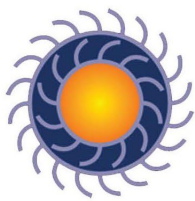

# Active Ventilation Products

Newburgh, NY • [roofvents.com](http://roofvents.com)

845-565-7770 • [sales@roofvents.com](mailto:sales@roofvents.com)



B. Color Samples: RAL color chart of selected colors located at <https://roofvents.com/color-chart-2>.



**Active Ventilation Products, Inc.**  
manufactures roof exhaust vents, roof intakes vents,  
solar attic fans, roof exhaust fans & more

## POWDER COAT COLOR CHART

Due to the custom nature of powder coated items, we are unable to accept returns.  
ALL POWDER COATED SALES ARE FINAL.

Unpainted		Standard Colors			
<b>ALUMINUM FINISH</b>	<b>GLOSS BLACK</b>	<b>RAL 9003 SIGNAL WHITE</b>	<b>RAL 6028 Pine Green</b>	<b>RAL 7039 Quartz Grey (Weatherwood)</b>	<b>RAL 8028 Terra Brown</b>
Premium Colors					
<b>RAL 1001 Beige</b>	<b>RAL 1013 Oyster White</b>	<b>RAL 1019 Grey Beige</b>	<b>RAL 1023 Traffic Yellow</b>	<b>RAL 1024 Ochre Yellow (Gold)</b>	
<b>RAL 2008 Bright Red Orange</b>	<b>RAL 3005 Wine Red</b>	<b>RAL 3007 Black Red</b>	<b>RAL 3009 Oxide Red (Barn Red)</b>	<b>RAL 3020 Traffic Red</b>	
<b>RAL 5012 Light Blue</b>	<b>RAL 5014 Pigeon Blue</b>	<b>RAL 5021 Water Blue</b>	<b>RAL 6002 Leaf Green</b>	<b>RAL 6011 Reseda Green</b>	
<b>RAL 6020 Chrome Green</b>	<b>RAL 6021 Pale Green</b>	<b>RAL 7003 Moss Grey</b>	<b>RAL 7012 Basalt Grey</b>	<b>RAL 7013 Brown Grey</b>	
<b>RAL 7015 Slate Grey</b>	<b>RAL 7022 Umbra Grey</b>	<b>RAL 7030 Stone Grey</b>	<b>RAL 7032 Pebble Grey</b>	<b>RAL 7037 Dusty Grey</b>	
<b>RAL 7040 Window Grey</b>	<b>RAL 8002 Signal Brown</b>	<b>RAL 8004 Copper Brown</b>	<b>RAL 8011 Nut Brown</b>	<b>RAL 8015 Chestnut Brown</b>	
<b>RAL 8019 Grey Brown (Burnished Slate)</b>	<b>RAL 8024 Beige Brown</b>	<b>COPPER</b>	<b>EARTH (Textured)</b>	<b>TERRA COTTA (Textured)</b>	

Active Ventilation Products, Inc. | 311 1st Street, Newburgh, NY 12550 | [www.roofvents.com](http://www.roofvents.com) | [sales@roofvents.com](mailto:sales@roofvents.com) | 1-800-766-3836

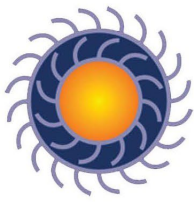

# Active Ventilation Products

Newburgh, NY • [roofvents.com](http://roofvents.com)

845-565-7770 • [sales@roofvents.com](mailto:sales@roofvents.com)



## C. Manufacturer's Written Instructions

<p>1" 4 1/2" 4 1/2" 1" 1" 4 1/2" 4 1/2" 1" Rounded Corner option</p>	<p>Roof Vent Drawing not to scale Flange Fastener Membrane Insulation Roof deck Opening = 6"</p>
<p><b>Keepa Vent - an Attic Roof Vent</b> Model: KV-6 Diameter: 6"</p>	<p><b>Keepa Attic Vent</b> <b>Detailed Installation Instructions</b></p> <ol style="list-style-type: none"> <li>1. Cut a circular hole 6" in diameter in the roof deck. Remove all debris.</li> <li>2. Apply sealant to the underside of the flange, then place vent down.</li> <li>3. Screw* vent onto roof deck, following the pattern as shown.</li> <li>4. Seal all seams and screws with an approved roofing sealant</li> </ol> <p><i>*Recommended installation screw: Flat, Bugle or Wafer Head #10 x 1 1/2" Steel Wood Screw, Type A Point</i></p> <p>Total number of screws needed = 8 (screws not included)</p>
<p> <b>Active Ventilation Products, Inc.</b> Visit us: <a href="http://roofvents.com">roofvents.com</a> Email us: <a href="mailto:sales@roofvents.com">sales@roofvents.com</a> 9/14/2023</p>	

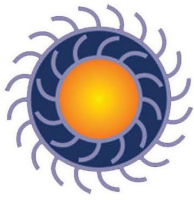

# Active Ventilation Products

Newburgh, NY • [roofvents.com](http://roofvents.com)

845-565-7770 • [sales@roofvents.com](mailto:sales@roofvents.com)



## 1.4 Quality Assurance

### A. Active Ventilation Products' Qualifications:

1. Active Ventilation Products has documented experience specializing in manufacturing roof vents since 1997. High-quality standards and quality control procedures followed in each phase of the manufacturing process and per the requirements of ISO 9001:2015.

### B. Installer's Qualifications:

1. Installer has specialized experience of work similar to that specified for this project, following manufacturer's installation instructions.

## 1.5 Information Submittals

- A. Coordination Drawings: Show the roof plan drawn to scale and indicate location of model KV-6.

## 1.6 Delivery, Storage and Handling

- A. Delivery Requirements: Deliver materials to site in manufacturer's original, unopened containers and packaging.
- B. Store vents in a secure location protected from theft and damage.

## 1.7 Coordination

- A. Provide drawings that show the locations of the KV-6 to the general contractor and roofer.
- B. Provide installation instructions of the KV-6 to the general contractor and roofer.
- C. Provide this product specification to the general contractor and roofer.

## 1.8 Warranty

- A. Manufacturer's 5-year warranty – Written warranty provided at [roofvents.com/warranties](http://roofvents.com/warranties)

- END OF PART 1 OF 3 -

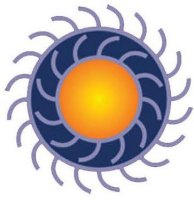

# Active Ventilation Products

Newburgh, NY • [roofvents.com](http://roofvents.com)

845-565-7770 • [sales@roofvents.com](mailto:sales@roofvents.com)



## PART 2 Products

### 2.1 Acceptable Manufacturers

A. Active Ventilation Products, Inc.,

311 1<sup>st</sup> Street, Newburgh, NY 12550

Website: <http://www.roofvents.com/>

Phone: 845-565-7770

E-mail: [sales@roofvents.com](mailto:sales@roofvents.com)

B. Substitutions: Not permitted

C. Request for substitutions will be considered in accordance with provisions of Section 01 60 00 - Product Requirements and notification to Active Ventilation Products, Inc.

### 2.2 Keepa Vent

A. Keepa Vent – Model KV-6

B. Description: KV-6 has 4 components: vent head, inner vertical louvers, collar and flat flange. The vent head is constructed with three components: a one piece spun aluminum round lid that will prevent rain and snow from entering the vent, cylinder shaped rain guard, and inner vertical louver. The cap and rain guard are beaded together to form the vent head. The cylinder shaped inner vertical louvers are attached inside the cap of the lid with screws. The inner vertical louvers will keep out insects, birds, and animals while allowing air to move through the vent with minimal resistance. The cylinder-shaped collar and flat flange are two separate components beaded together as one unit that is inseparable, otherwise known as the collar base. The vent head assembly is attached to the collar base assembly with screws to the bottom of the vent head. This allows the vent head to be removed if necessary and for easy access into the attic.



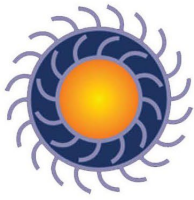

# Active Ventilation Products

Newburgh, NY • [roofvents.com](http://roofvents.com)

845-565-7770 • [sales@roofvents.com](mailto:sales@roofvents.com)



1. Material for Vent: Aluminum
  - a. Lid
    - (i) Thickness: 0.025 inch
    - (ii) Alloy: 1100 or 3003
  - b. Inner Vertical Louvers
    - (i) Thickness: 0.025 inch ≈ Gauge no. 24 Steel thickness
    - (ii) Alloy: 3003-H14 Half Hard
  - c. Collar
    - (i) Thickness: 0.025 inch ≈ Gauge no. 24 Steel thickness
    - (ii) Alloy: 3003 H14 Half Hard
  - d. Flange (Flashing)
    - (i) Thickness: 0.025 inch ≈ Gauge no. 24 Steel thickness
    - (ii) Alloy: 3003 H14 Half Hard
  - e. Rivets for Collar
    - (i) Size: 3/16" x 1/8"
    - (ii) Alloy: 6061
2. Material for Screws: 410 Stainless Steel
  - a. Head Fasteners
    - (i) Size: #6 x 3/8"
    - (ii) Head: Square Drive
    - (iii) Point: AB Point, Self-Tapping
  - b. Collar Fasteners
    - (i) Size: #8 x 1/2"
    - (ii) Head: Hex
    - (iii) Point: Self-Tapping

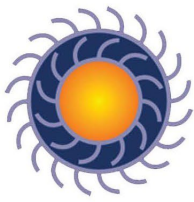

# Active Ventilation Products

Newburgh, NY • [roofvents.com](http://roofvents.com)

845-565-7770 • [sales@roofvents.com](mailto:sales@roofvents.com)

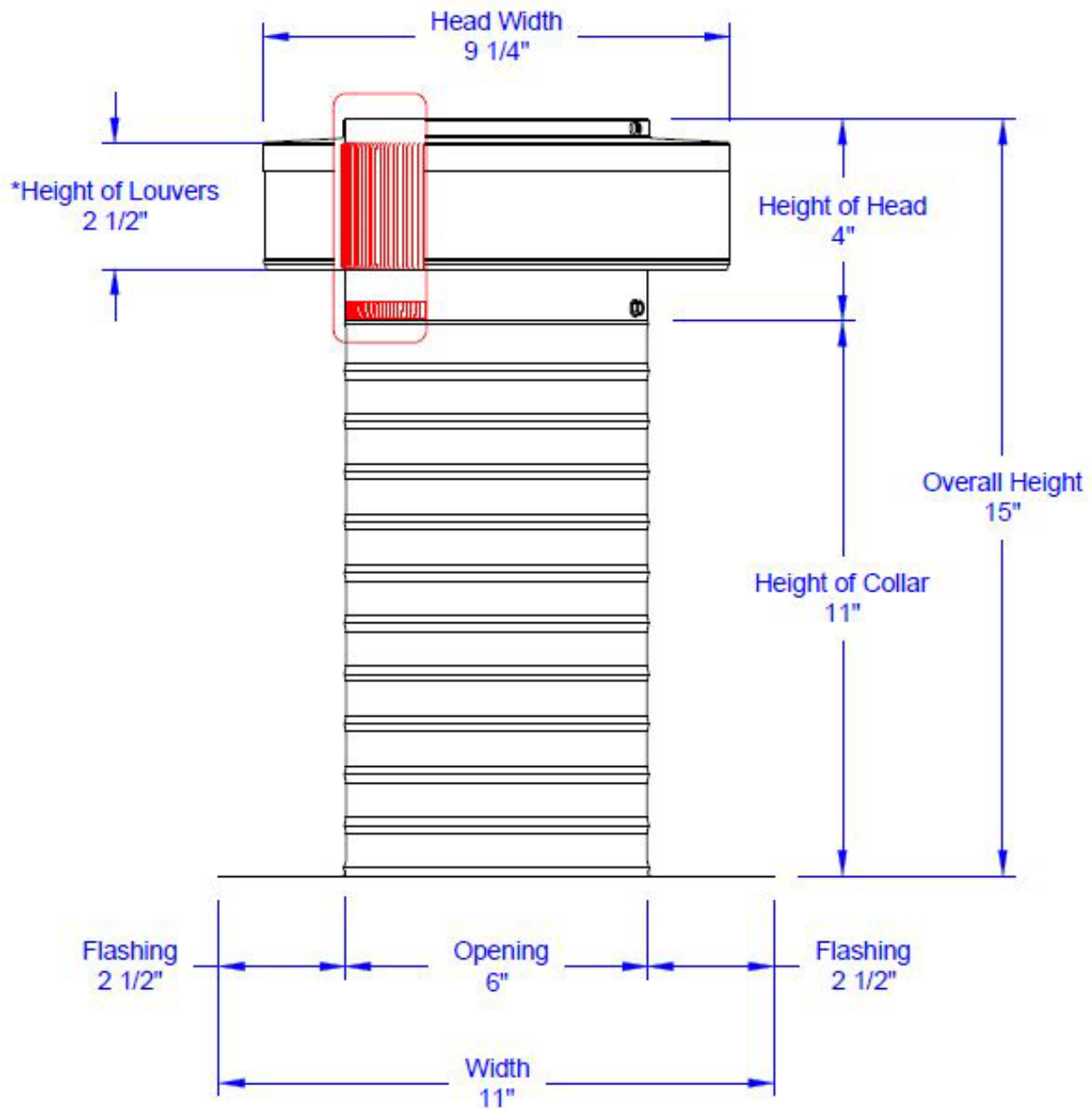

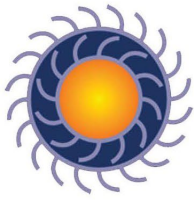

# Active Ventilation Products

Newburgh, NY • [roofvents.com](http://roofvents.com)

845-565-7770 • [sales@roofvents.com](mailto:sales@roofvents.com)



3. Size:
  - a. Inside diameter: 6 inches
  - b. Width of Vent Head: 9.25 inch
  - c. Height of Vent Head: 4 inches
  - d. Collar Height: 11 inches
  - e. Flange: 11 inches (square or rounded corners)
  - f. Flashing: 2.5 inch
  - g. Inner vertical louver: 2 1/2-inch height
  - h. Opening between blades of Inner Vertical Louver: 1/8 inch
  - i. Total height including collar: 15 inches
  - j. Net Free Area: 28 square inches
  - k. Net Free Area: 0.19 square feet
  - l. Minimum Pitch Capacity: 0/12
  - m. Maximum Pitch Capacity: 24/12
  - n. Recommended use for: 0/12 to 3/12
    - (i) If used for higher pitches (4/12 – 12/12), the installer needs to use a guide wire.
4. Standard Finish: Mill finished aluminum
5. Optional Color Finish: Selected RAL colors located on [roofvents.com/color-chart-2](http://roofvents.com/color-chart-2)
  - a. Paint is applied by using an electrostatic powder coating process.
6. Operation: Gravity, static, passive (non-motorized)

**- END OF PART 2 OF 3 -**

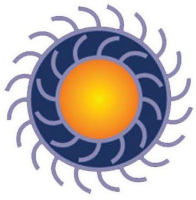

# Active Ventilation Products

Newburgh, NY • [roofvents.com](http://roofvents.com)

845-565-7770 • [sales@roofvents.com](mailto:sales@roofvents.com)



## PART 3 Execution

### 3.1 Ventilation Requirement

- A. Application: One Vent per square foot print of the attic floor
  - 1. Venting Rule 1:150: KV-6 = 50 square feet
  - 2. Venting Rule 1:300: KV-6 = 100 square feet
- B. Refer to the Venting Requirements Calculator on <https://roofvents.com/active-ventilation-products-attic-vent-calculator> to calculate the total quantity of KV-6 needed per square foot.
- C. Net Free Area per KV-6 = 28 square inches, (0.19 square feet)

### 3.2 Examination

- A. Examine site conditions and verify that structural supports and openings are properly sized, prepared and ready to receive the Keepa Vent model KV-6.
  - 1. Proceed with installation only after unacceptable conditions have been remedied.

### 3.3 Preparation

- A. From the building plans locate the placement of Keepa Vent KV-6 on the roof.
- B. Prepare roof deck to receive the KV-6 with the accessories in accordance with the written installation instructions.

### 3.4 Flat Roof Installation

- A. *Flat Roof Detailed Installation Instructions*

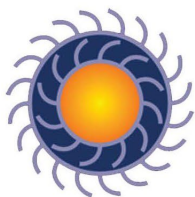

# Active Ventilation Products

Newburgh, NY • [roofvents.com](http://roofvents.com)

845-565-7770 • [sales@roofvents.com](mailto:sales@roofvents.com)



## Step 1:

Turn the vent upside down and make a cardboard template from the flange. The template should be the same size as the flange with the hole in the middle.



## Step 2:

Using the template, trace the square and circle onto the roof as shown.

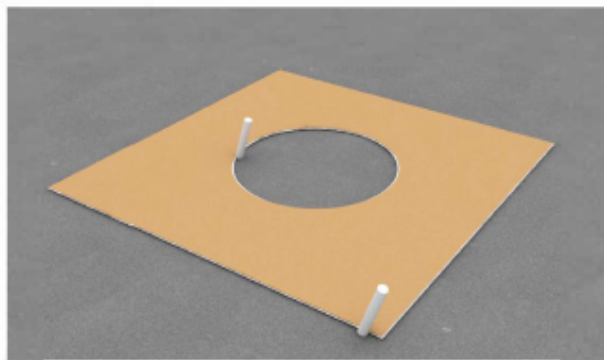

## Step 3:

Remove cardboard template, The square and circle pattern shown.

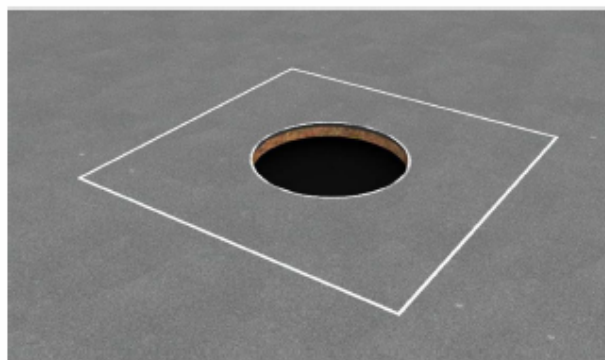

## Step 4:

With a razor blade, cut the circle traced out onto the membrane and remove. Then with a reciprocating saw, cut a hole in the roof deck and remove all debris.

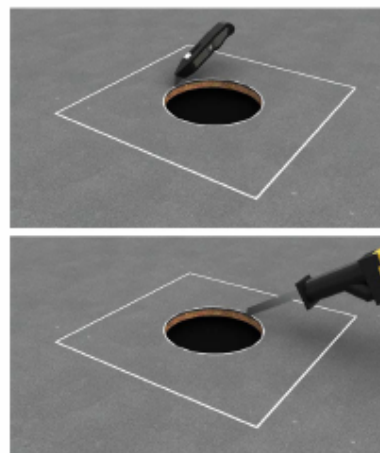

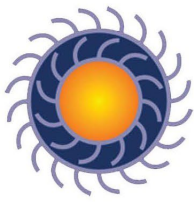

# Active Ventilation Products

Newburgh, NY • [roofvents.com](http://roofvents.com)

845-565-7770 • [sales@roofvents.com](mailto:sales@roofvents.com)



## Step 5:

Apply sealant within the square flange outline.

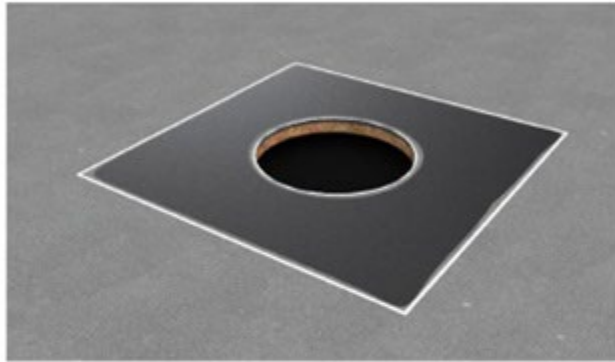

## Step 6A:

Place vent within the square outline & attach using a screw gun or drill



## 6B:

Required screw: #10 x 1.5" steel sheet metal screw  
Total number of screws required = 8

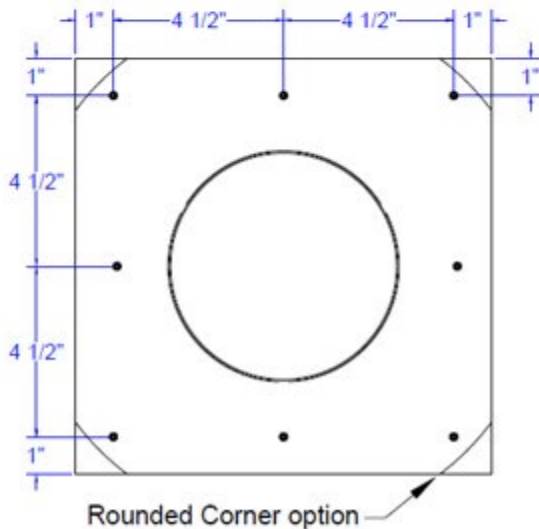

## Step 7:

Apply roofing cement over the screws and edge of flange. This is how the keepa vent should look when finished

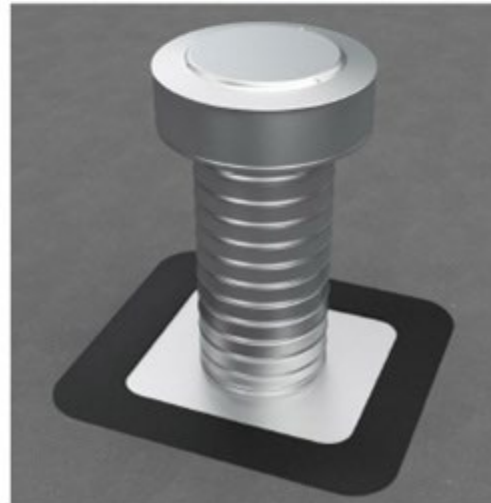

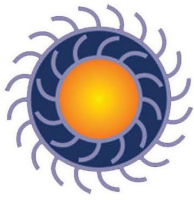

# Active Ventilation Products

Newburgh, NY • roofvents.com

845-565-7770 • sales@roofvents.com



## B. Accessories to be provided by installer:

1. Sealant: Installer provides sealant recommended for the application and type by roofing manufacturer or construction material manufacturer. Comply with requirements of Section 07 92 00 – Joint Sealants.
2. Fasteners: Installer provides corrosion resistant Flat, Bugle or Wafer Head #10 x 1 ½” Sheet Metal Screws, Type A Point.

## 3.5 Cleanup

- A. Upon completion, remove surplus materials, rubbish, tools and equipment.

**- END OF PART 3 OF 3 -**