

For Membrane Roofs

Step 1:

Turn the vent upside down and make a cardboard template from the flange. The template should be the same size as the flange with the hole in the middle.



Step 2:

Using the template, trace the square and circle onto the roof as shown.

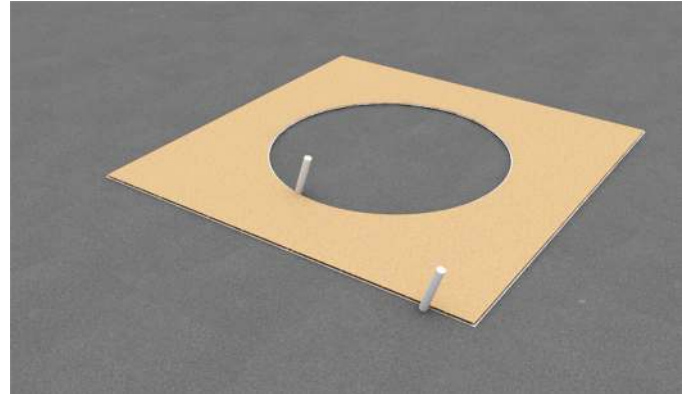

Step 3:

Remove cardboard template to show the square and circle pattern shown.

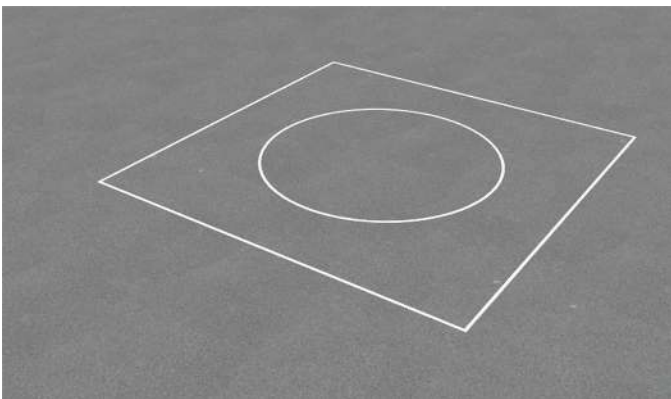

Step 4:

With a razor blade, cut the circle traced out into the membrane and remove. Then with a reciprocating saw, cut a hole in the roof deck and remove all debris.

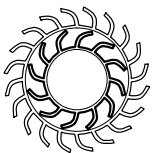
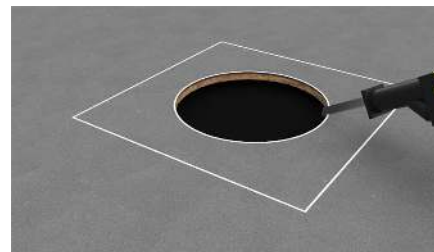

Active Ventilation Products, Inc.

311 First Street, Newburgh, NY 12550-4857

800-ROOF VENT (766-3836) Ph: 845-565-7770 Fax: 845-562-8963

Website: roofvents.com Email: sales@roofvents.com

5778-11

Installation Instructions for KV-9

For EPDM Membrane Roof or Hot Tar Roof

Step 5:

Apply sealant within the square flange outline.

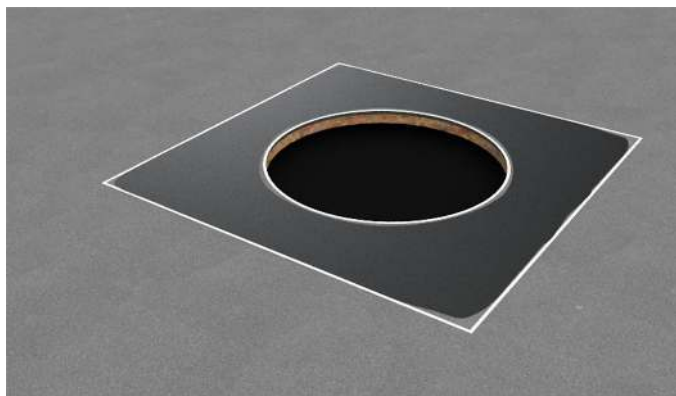

Step 6:

Place vent within the square outline & attach using a screw gun or drill.



Step 7:

Required screw: #10 x 1.5" steel sheet metal screw total number of screws required = 16 (tolerance: 1/2")

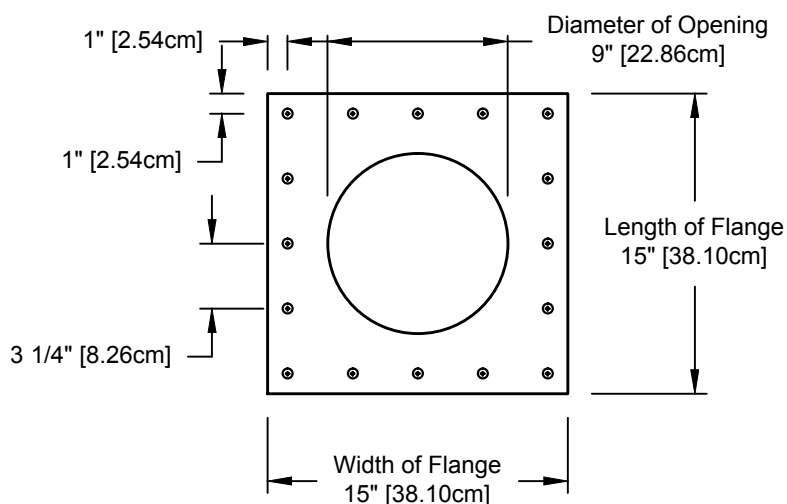

Step 8:

Apply roofing cement over the screws and edge of flange. This is how the Keepa Vent should look when finished.

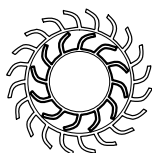

Active Ventilation Products, Inc.

311 First Street, Newburgh, NY 12550-4857

800-ROOF VENT (766-3836) Ph: 845-565-7770 Fax: 845-562-8963

Website: roofvents.com Email: sales@roofvents.com

5778-11