

Pitch Pan Flashing Detail

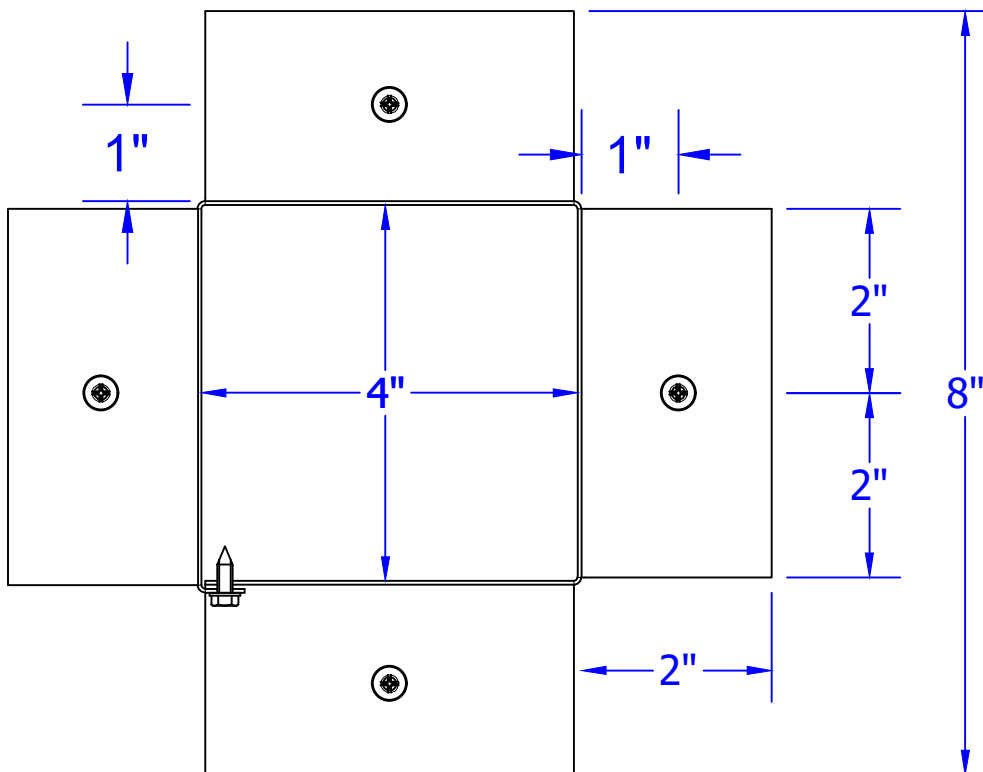
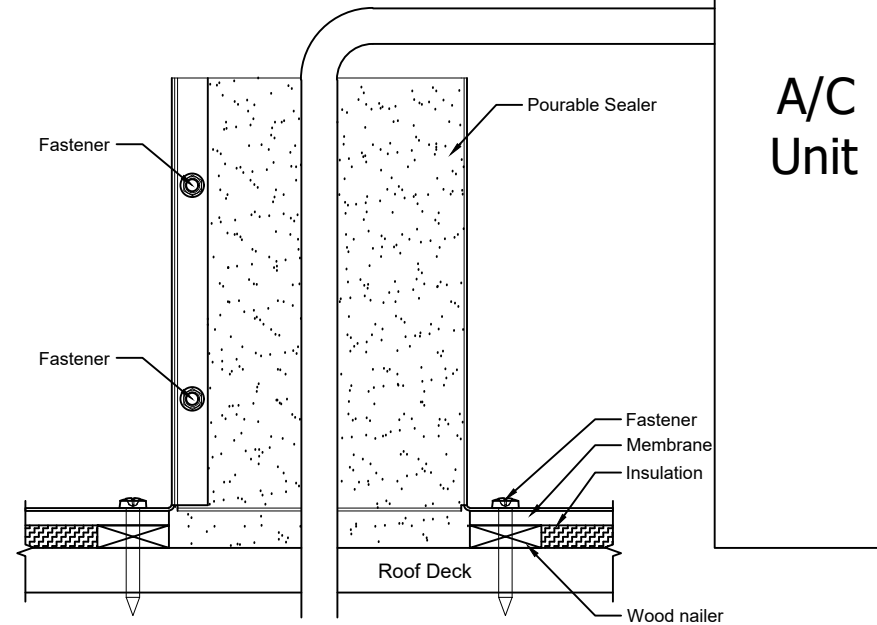
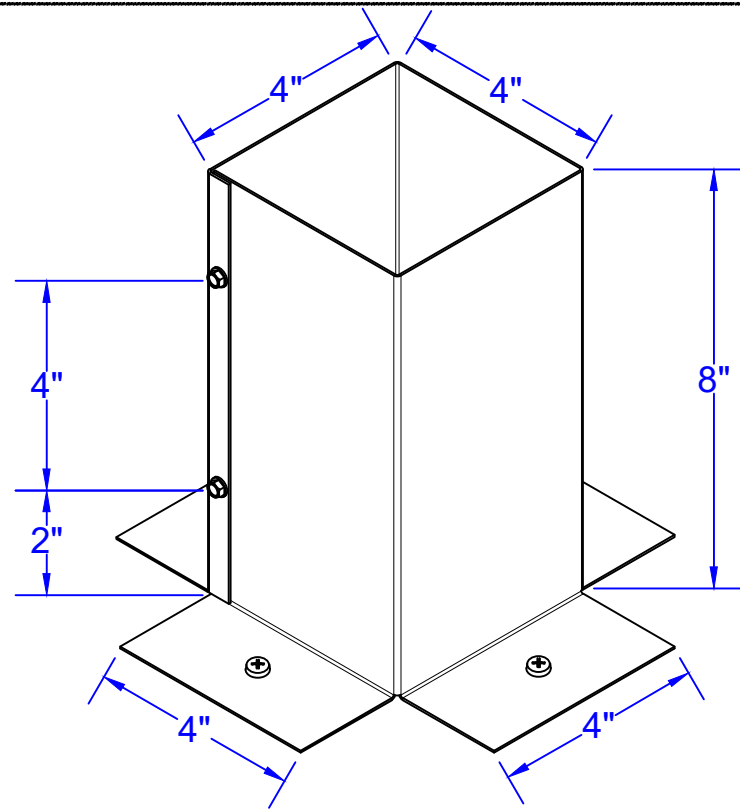

Installation Instructions

1. Slide pitch pan around plumbing or electrical conduit.
2. To install pitch pan onto the roof deck, use one screw or roofing nail per flange. The screws should be approximately in the center of the flange.
3. Total number of screws or nails needed for flanges = 4
4. To close the pitch pan, use two, #8 x 1/2" screws
5. *Recommended installation screw: #10 x 1 1/2" Steel Sheet Metal Screw, Pan Head, Phillips Drive. Type "A" Point, Zinc Plate Finish*
6. Flash pitch pan onto roof according to specifications of the roof manufacturer.
7. Screws not included.

Pitch Pan PP-4x4-H8

Inner Diameter = 4", Outer Diameter = 8", Height = 8"

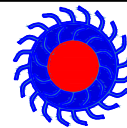

Active Ventilation Products, Inc.

Website: roofvents.com

Email: sales@roofvents.com

7/30/2021