

### Step 1:

Turn the vent upside down and make a cardboard template from the flange. The template should be the same size as the flange with the hole in the middle.



### Step 2:

Using the template, trace the square and circle onto the roof as shown.

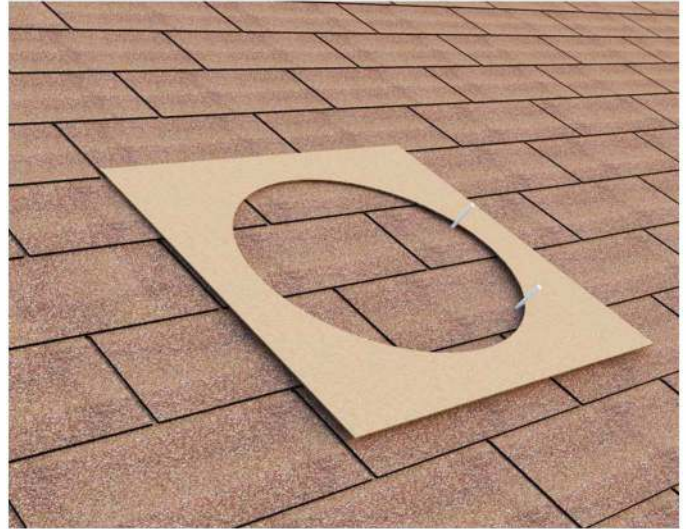

### Step 3:

Remove cardboard template to show the square and circle pattern.



### Step 4:

Using a reciprocating saw cut out a hole in the roof deck and remove all debris.



### Step 5:

Put roofing sealant on the underside along the bottom edge of flange as shown.

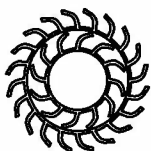

## Active Ventilation Products, Inc.

311 First Street, Newburgh, NY 12550-4857

800-ROOF VENT (766-3836) Ph: 845-565-7770 Fax: 845-562-8963

Website: [roofvents.com](http://roofvents.com) Email: [sales@roofvents.com](mailto:sales@roofvents.com)

5778-6

**Step 6:**

Slide vent underneath the shingles, stay within the square outline.



**Step 7A:**

With the vent in place secure the flange to the shingle roof using a screw gun or drill



**7B:**

Required Screw: #10 x 1.5" steel sheet metal screw  
Total number of screws required = 16 (tolerance: 1/2")

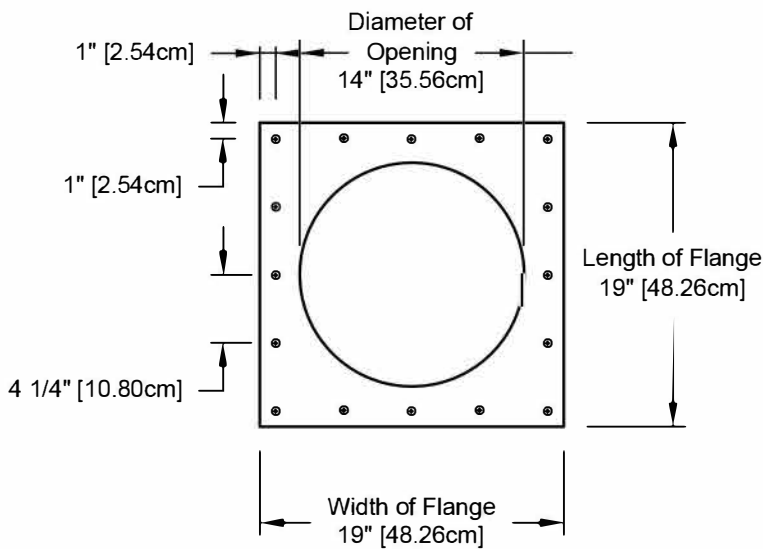

**Step 8:**

This is how the Pop Vent should look when finished

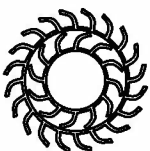

**Active Ventilation Products, Inc.**

311 First Street, Newburgh, NY 12550-4857

800-ROOF VENT (766-3836) Ph: 845-565-7770 Fax: 845-562-8963

Website: roofvents.com Email: sales@roofvents.com

5778-6