

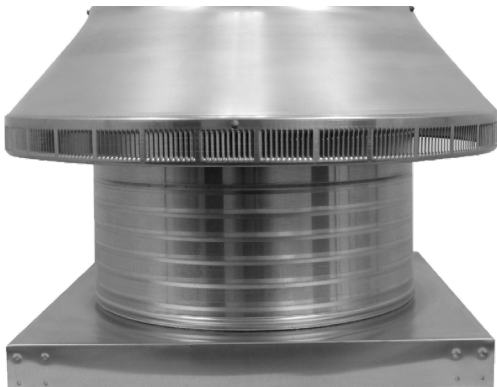

Pop Vent with Curb Mount Flange

Model Number: PV-16-C6-CMF | 16" Diameter 6" Tall Collar



- Allows fresh air to enter the attic or plenum
- Louvers prevent rain, snow and wildlife from entering inside
- Can be used as a hatch to service the attic or plenum
- Can be modified with a tail pipe if duct venting is required
- Suitable for every climate zone on roof curbs
- Constructed of durable rust-free aluminum
- 5 Year Warranty

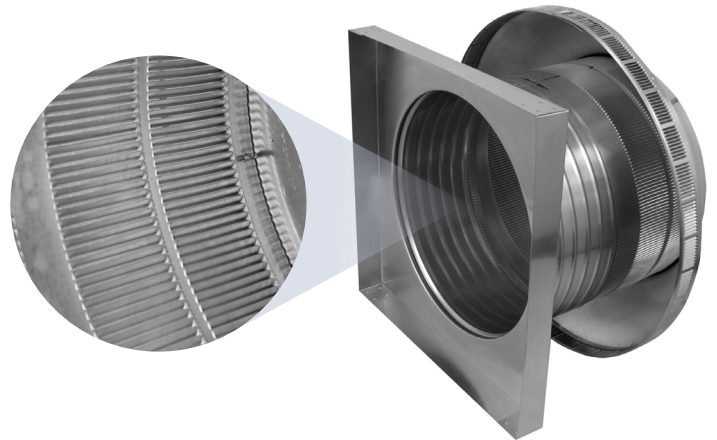

Dimensions & Specifications 200 Sq. in. NFA

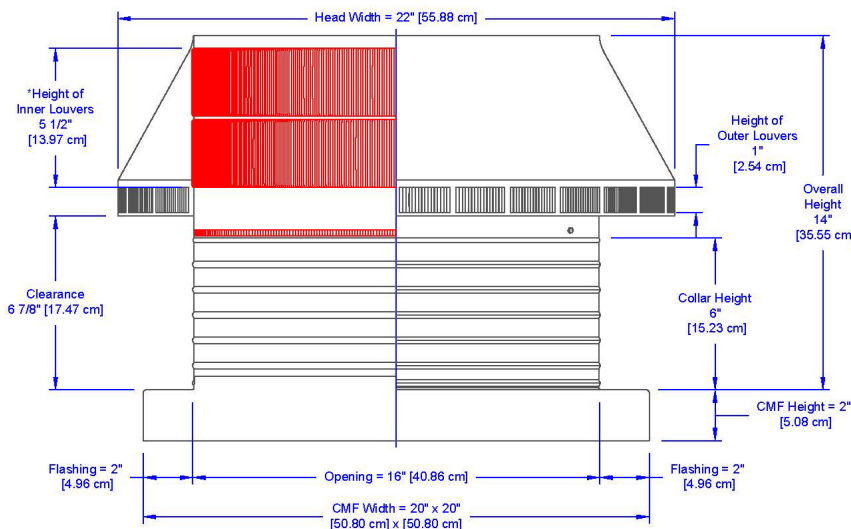

Net Free Vent Area	
(sq. inches)	(sq. feet)
200	1.39
Application per Sq. Foot	
(1/150)	(1/300)
416	833
Weight	
13 lbs	