



Round Back Static Vent with Curb Mount Flange

Model Number: RBV-10-C2-CMF | 10" Diameter 2" Tall Collar



- Round Back Static Vents removes hot air in the summer and moisture in the winter for year-round attic ventilation
- Curb Mount Flange fits over roof curbs for easy installation
- Engineered to prevent rain or snow and wildlife from entering
- Can be used as a hatch to service the attic or plenum
- Constructed of durable rust-free aluminum
- 5 Year Warranty

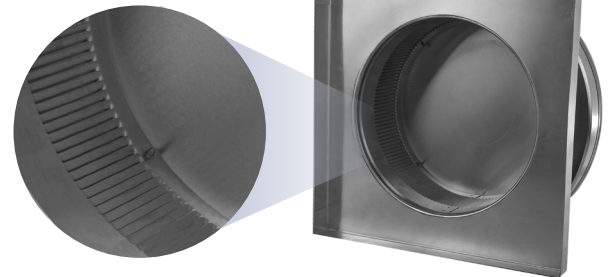

View of Inner Louvers

Dimensions & Specifications 78 Sq. in. NFA

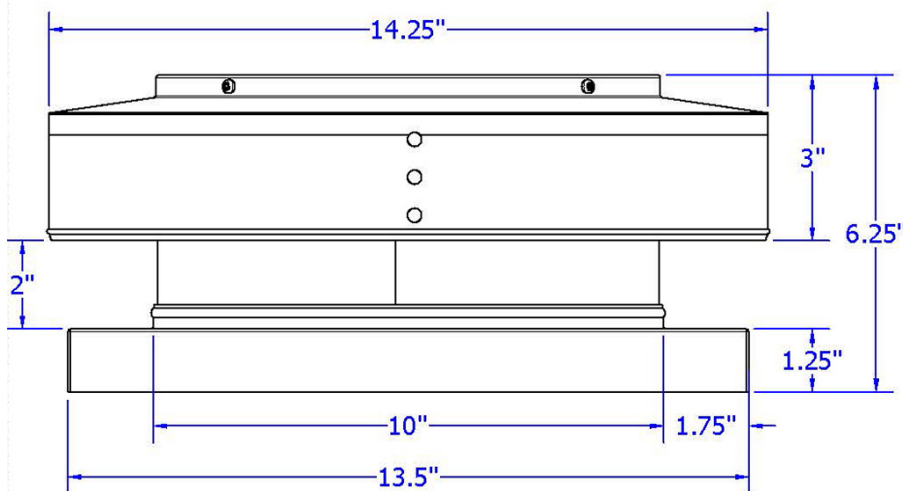

Net Free Vent Area	
(sq. inches)	(sq. feet)
78	0.54
Application per Sq. Foot	
(1/150)	(1/300)
162	325