

Installation Instructions for RBV-5-C2-SM-rib

"A low profile roof vent for R-Panel metal roofs such as SM-Rib, Tuff-Rib, Panel-Loc Plus & Master Rib"

Step 1:

Turn the vent upside down and make a cardboard template of the flange. The template should be 7 1/4" wide and 12" long with a 5" hole in the middle.

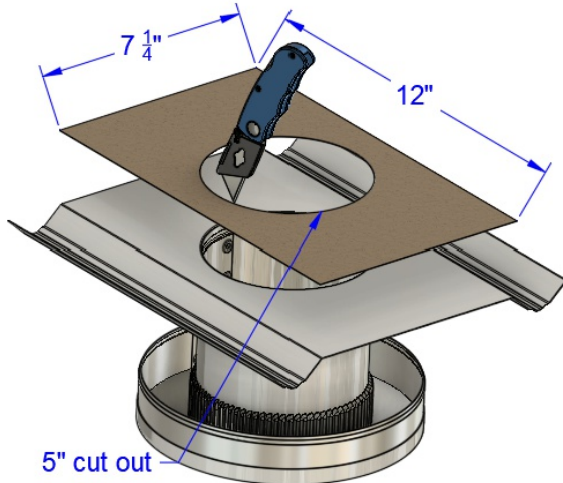

Step 2:

Using the template trace the hole onto the roof panel centered in between the ribs, making sure the upper edge of the template is over the ridge cap by at least 1".

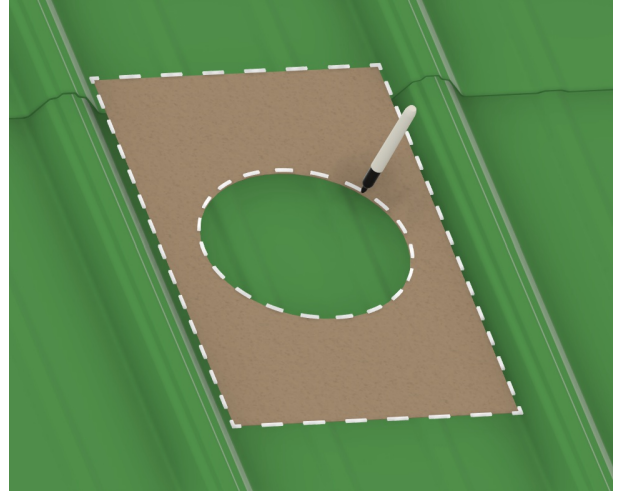

Step 3:

Using nibbler, snips or hole saw cut 5" hole in roof panel and remove all debris.

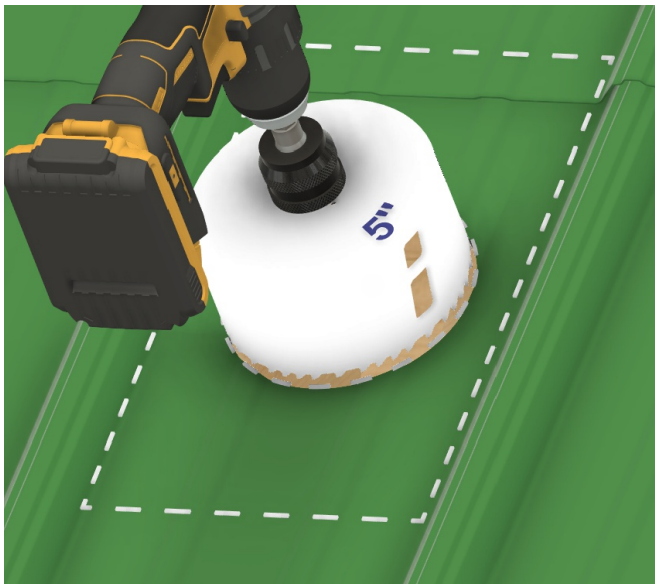

Step 4:

Place 3/4" butyl tape on all four sides of the flange. The tape should overlap at each corner.

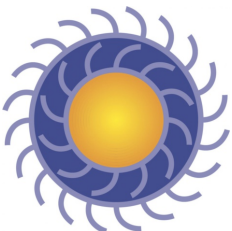
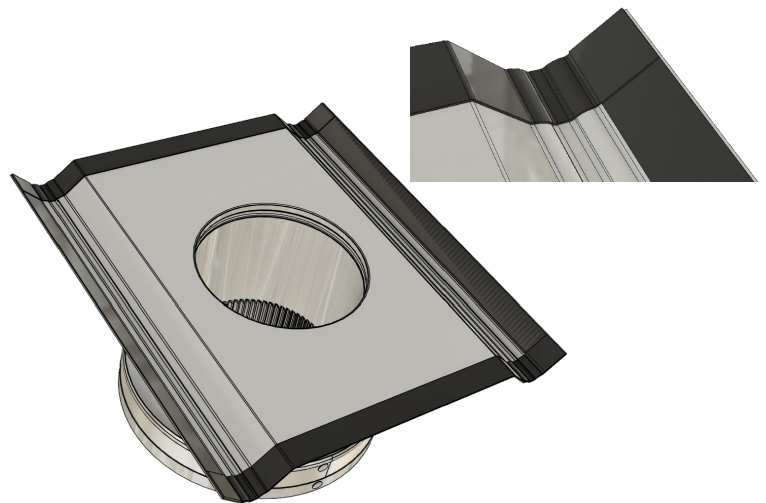

Active Ventilation Products, Inc.

311 First Street, Newburgh, NY 12554-4857

800-ROOF VENTS (766-3836) Ph: 845-565-7770 Fax: 845-562-8963

Website: roofvents.com Email: sales@roofvents.com

Installation Instructions for RBV-5-C2-SM-rib

"A low profile roof vent for R-Panel metal roofs such as SM-Rib, Tuff-Rib, Panel-Loc Plus & Master Rib"

Step 5:

Install vent so that the bottom edge of flange aligns with templete marks.

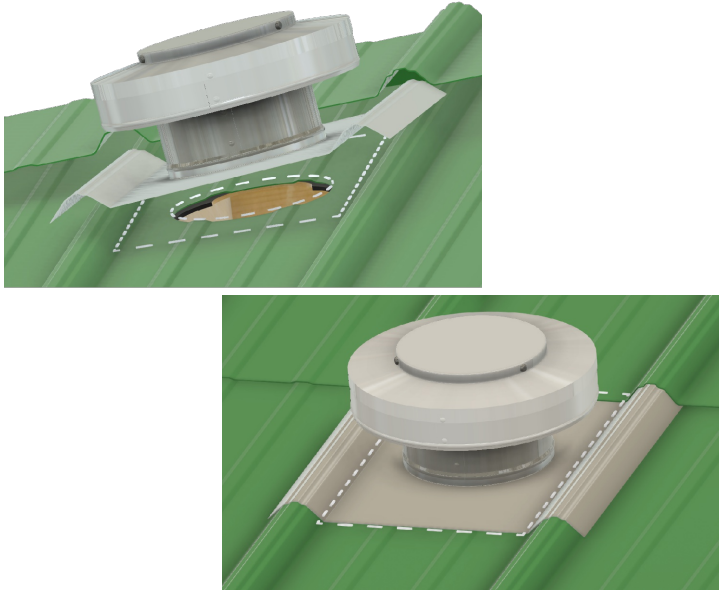

Step 6A:

Use #10 self tapping screws with rubberized washers secure the flange to the roof following the pattern shown in **6B**.

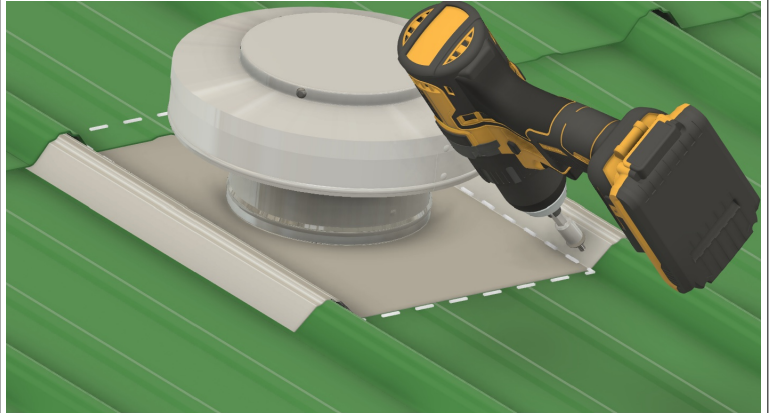

Step 6B:

Install screws as shown below. Qty 16

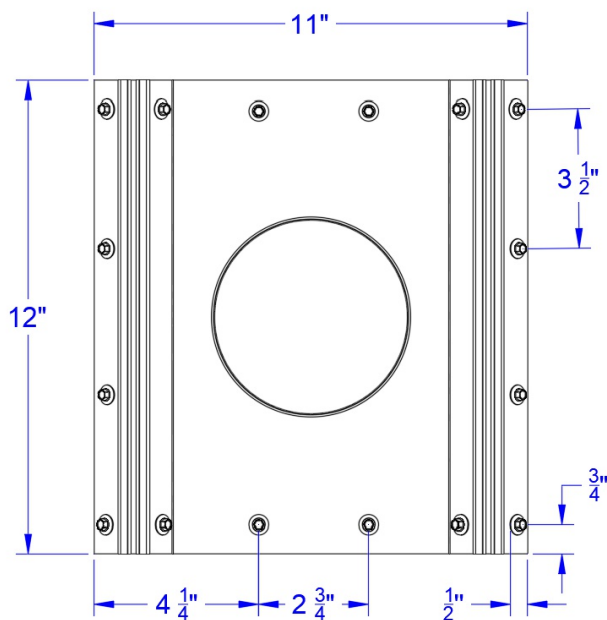

Step 7:

This is how the Round Back Vent should look when finished.

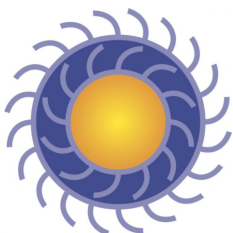
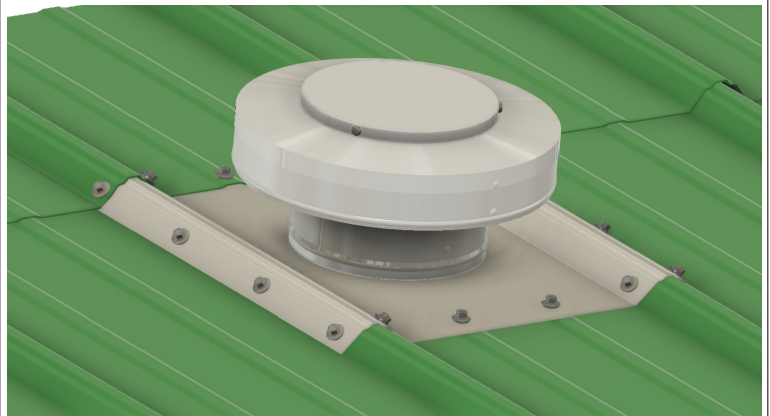

Active Ventilation Products, Inc.

311 First Street, Newburgh, NY 12554-4857

800-ROOF VENTS (766-3836) Ph: 845-565-7770 Fax: 845-562-8963

Website: roofvents.com Email: sales@oofvents.com