

Round Back Static Roof Vent

Model Number: RBV-6-C2 | 6" Diameter 2" Tall Collar

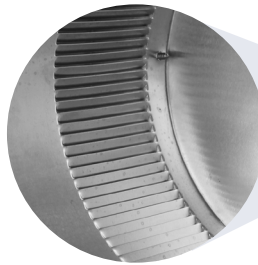

- Removes hot air in the summer and moisture in the winter for year-round attic ventilation
- Engineered to prevent rain, snow and wildlife from entering
- Air flows freely through inner louvers better than insect screen
- Constructed of durable rust-free aluminum
- UL Certified, Florida State & California Fire Code approved; Tested to withstand wind speeds of 200+ mph
- 5 Year Warranty



Dimensions & Specifications 28 Sq. in. NFA

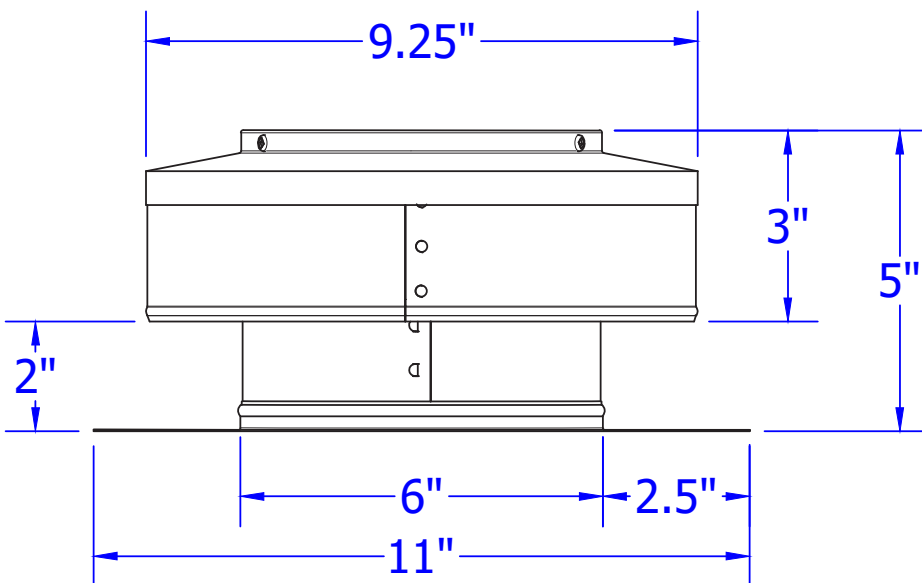

Pitch Capacity	
Min.	Max.
3/12	12/12
Net Free Vent Area	
(sq. inches)	(sq. feet)
28	0.19
Application per Sq. Foot	
(1/150)	(1/300)
58	108
Weight	
0.8 lbs	