



Round Back Vent

Model Number: **RBV-6-C2** | 6" Diameter 2" Tall Collar



- Removes hot air in the summer and moisture in the winter for year round attic ventilation
- Internal louvers block rain, snow, and wildlife intrusion
- Constructed of durable rust-free aluminum
- UL Listed (20170510-R38772), Intertek (105373987CRT-004b), Florida & Texas Approved (FL4763-R4), and Miami-Dade Approved (22-0722.08)
- Tested to withstand wind speeds of 200+ mph
- Available in five durable powder-coated colors

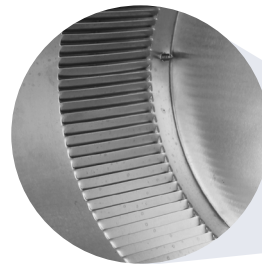

Dimensions & Specifications 28 Sq. in. NFA

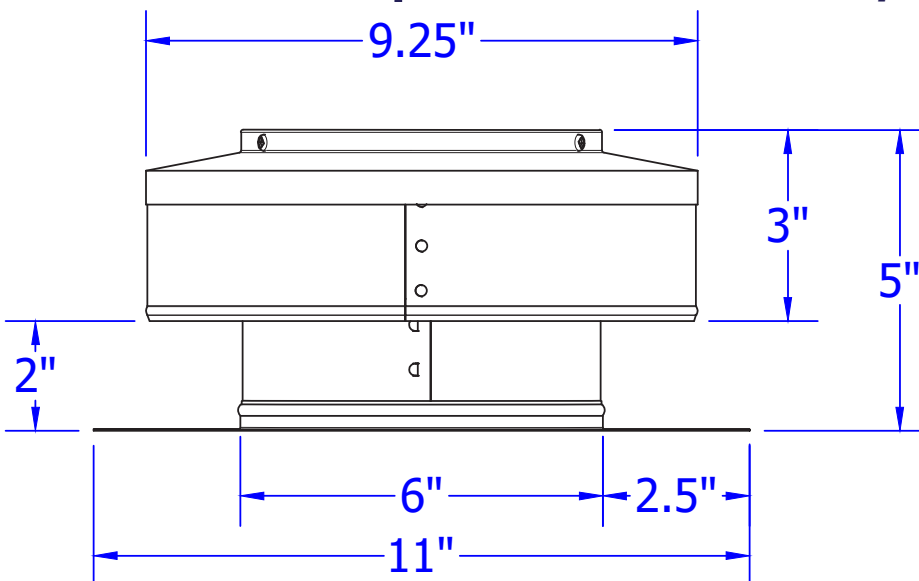

Pitch Capacity	
3/12 Min.	12/12 Max
Net Free Vent Area	
28 sq. in.	0.19 sq. ft.
Application per Sq. Ft.	
58 1/150	108 1/300
Weight = 0.8 lbs	