

Curb Mount Flange Detail

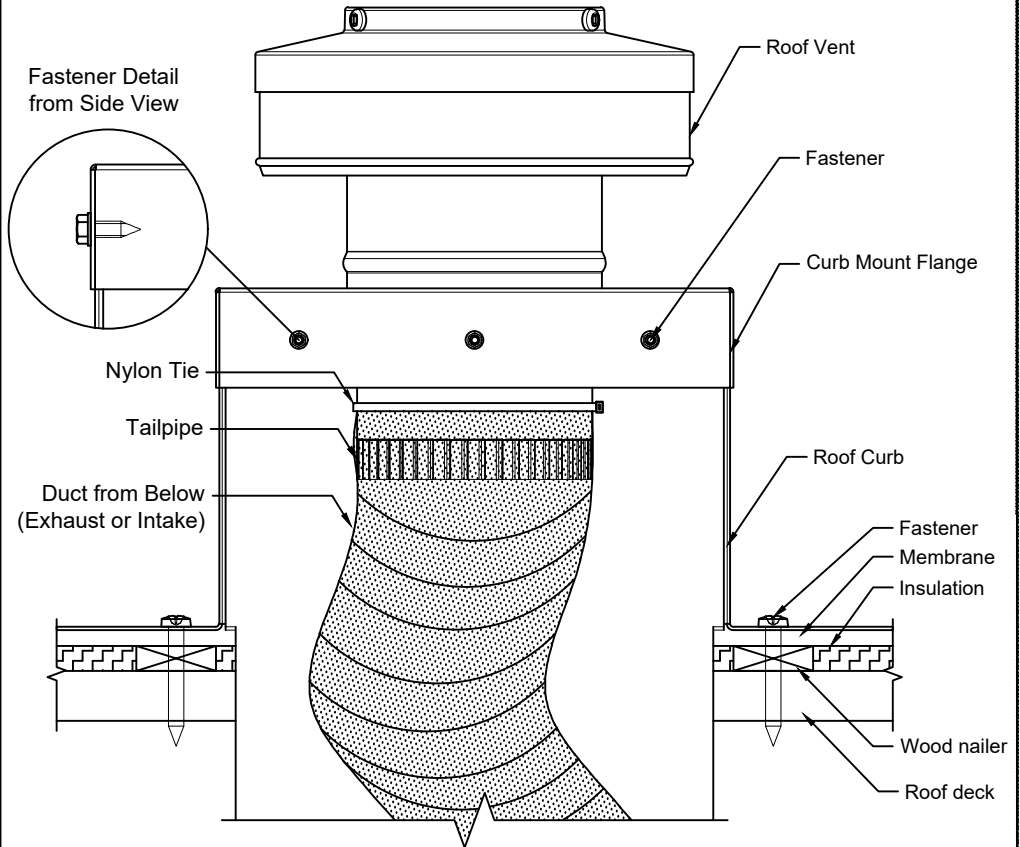

Curb Mount Flange Installation Instructions

1. Attach duct to Tailpipe with nylon tie.
2. Slide Curb Mount Flange onto the roof curb.
3. Attach Curb Mount Flange to roof curb using fasteners.
4. *Recommended installation screw: #8 x 1/2" Sheet Metal Screw*
5. Total number of screws needed for CMF = 12
6. Screws not included.

Round Back Vent with CMF & Tailpipe

Model: RBV-6-C4-CMF-TP

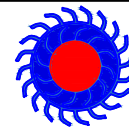

Active Ventilation Products, Inc.

Website: roofvents.com

Email: sales@roofvents.com

9/21/2021

