

Angled View

Top View

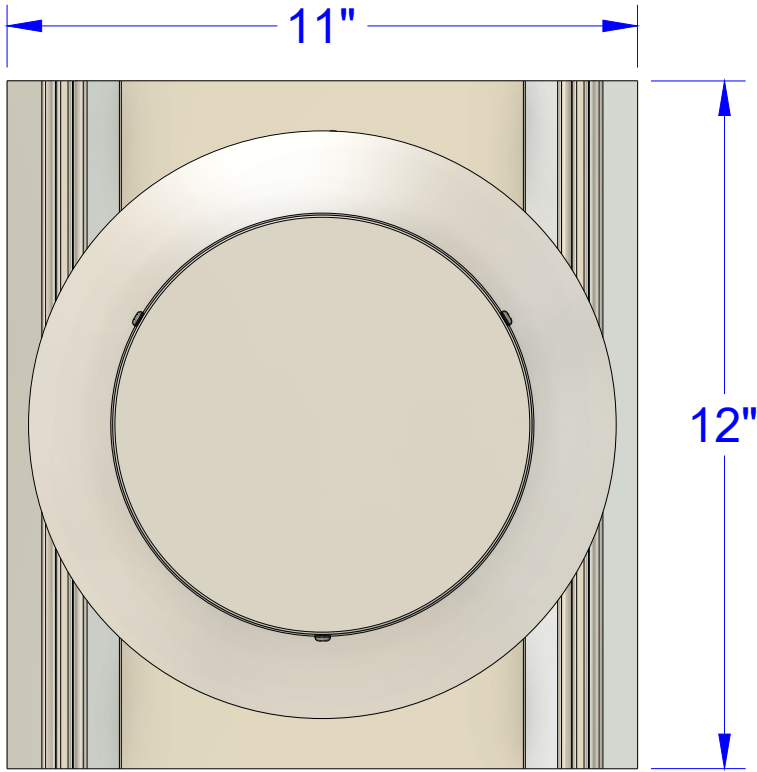

2 1/2" louver height with 1/8" opening

Front View

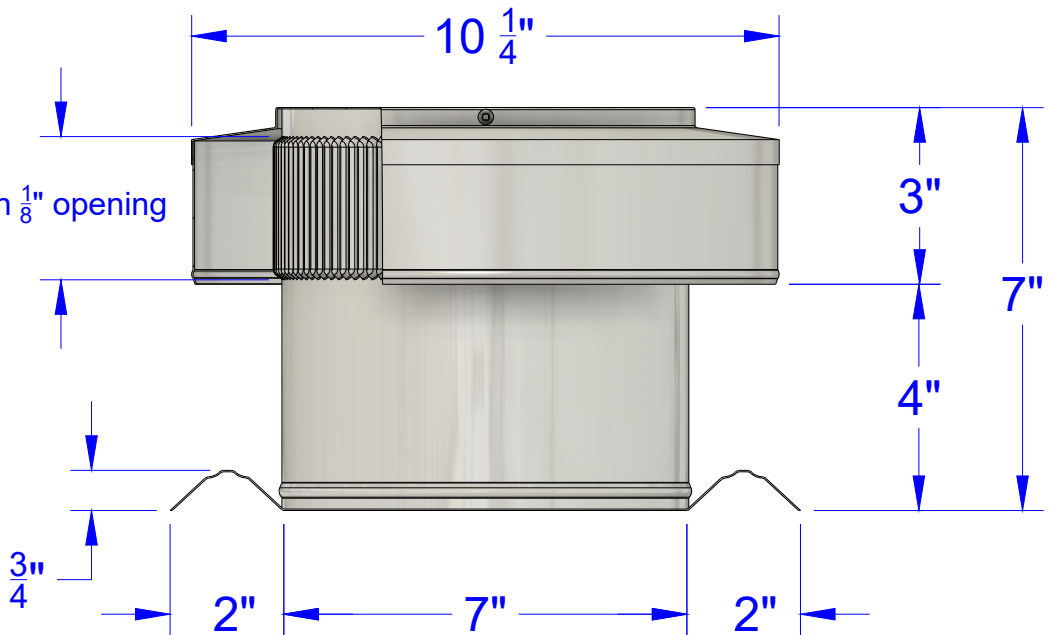

All dimensions are in inches

Active Ventilation Products

Material Thickness:	.025 ± .005
Tolerance:	±.25 (1/4")
Scale:	Not to Scale

Drawn By:	Date:
R. Larsen	5/12/2026

Technical Drawing for
RBV-7-C4-SM-rib

