

Round Back Vent for Metal Roofs

Model Number: RBV-7-C4-SM-rib
7" Diameter | 4" Tall Collar

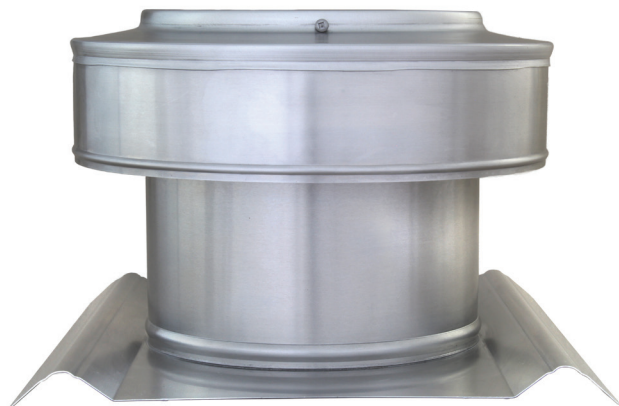

- Efficient year-round attic ventilation exhausts hot air in the summer and reduces moisture in the winter
- Designed to integrate seamlessly with R-Panel designs such as: **Tuff Rib, SM-Rib, Panel-Loc Plus, AG-Rib and Master Rib**
- Internal louvers block rain, snow, and wildlife intrusion
- Compatible with roof pitches of 2/12 or greater
- Available in five durable powder-coated colors

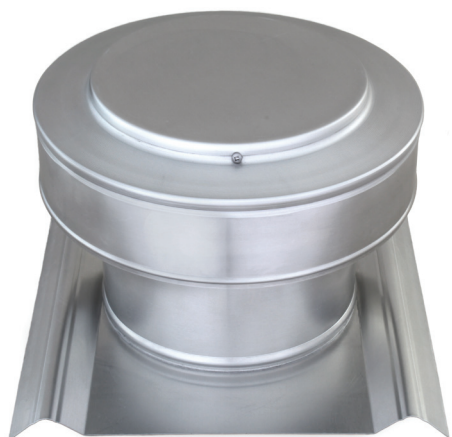

Dimensions & Specifications

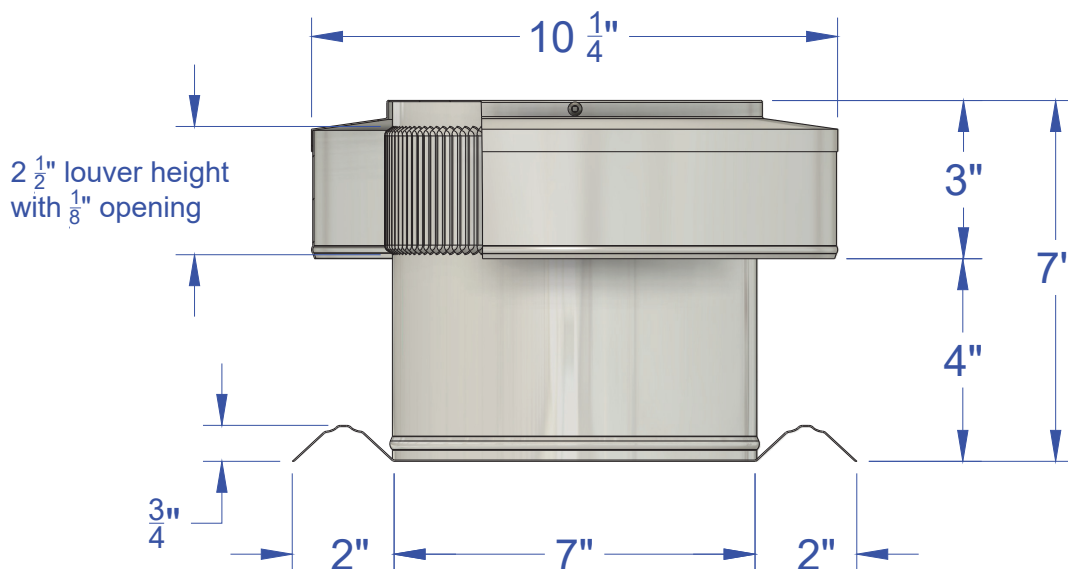

Louver design prevents insects and wildlife from entering

Pitch Capacity	
2/12 Min.	12/12 Max.
Net Free Vent Area	
38 sq. in.	0.26 sq. ft.
Application per Sq. Ft.	
79 1/150	158 1/300
Weight = 1.03 lbs	