



Active Ventilation Products

Newburgh, NY • roofvents.com

845-565-7770 • sales@roofvents.com



Roof Accessories 07 72 00

Round Back Vent 3-Part Spec – Model: *RBV-8-C2*

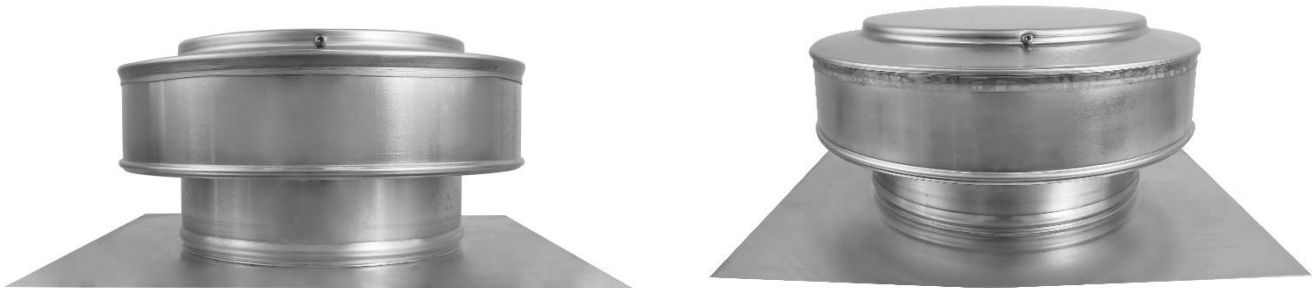

Figures 1-4: Side View, Angled Top View, Inside & Outside View of Louvers

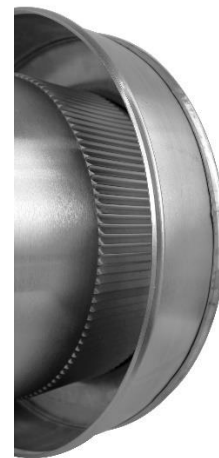
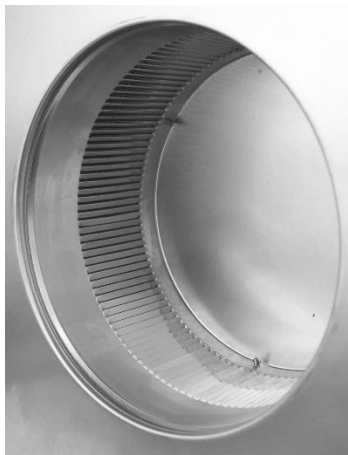

Definition / Purpose – Active Ventilation Products' Round Back Static Roof Vent is used to ventilate pitched roofs of 3/12 to 12/12. The Round Back Static Roof Vent is an exhaust vent that exhausts the hot, moist, stale air out of an attic cavity. Ventilating the roof not only adds years of life to the roof but also makes the home or building more energy efficient. The Round Back Static Roof Vent will last the roof's life even in corrosive-prone oceanfront areas, because it is manufactured from aluminum. Built to be low profile, the Round Back Static Roof Vent is engineered to work properly even in the harshest weather conditions. The Round Back's round aerodynamic design will withstand wind pressure exceeding 200 mph and will keep insects and animals from entering the attic.

Florida DBPR Approved & UL Listed, The Round Back Vent is proudly designed, and fabricated, and assembled in the U.S.A.



Active Ventilation Products

Newburgh, NY • roofvents.com

845-565-7770 • sales@roofvents.com



This guide is written under the Construction Specifications Institute (CSI) 3-Part Specification using *CSI MasterFormat 2020 Edition*. All section numbers and titles are based on *MasterFormat 2020 Edition*.

The CSI Master number classification for this product's division, subsection number, and titles are the following:

07 00 00 Division: Thermal and Moisture Protection

07 72 00 Section: Roof Accessories

07 72 23 Title: Relief Vent (Roof Vent)

Company Bio: Active Ventilation Products, Inc. (AVP) was founded in 1997 and is an innovative sheet metal fabrication facility located in Newburgh, NY. AVP produces high-quality spun aluminum roof vents, commercial roof exhaust fans, residential attic fans, solar attic fans, roof curbs, and roof accessories. Roof Vents range in size from 3 inches in diameter to 48 inches. Collar heights range from 1 inch to 12 inches.

Headquartered in the Hudson Valley of New York, AVP is housed in a 63,000-square-foot building with over 50 sheet metal fabricators on staff.

The management of Active Ventilation Products is committed to providing high-quality products and services that meet or exceed the customers' expectations. It is believed that quality is a result of the process involving continuous improvement, innovation, and learning.

Active Ventilation Products, Inc., is located at

311 1st Street, Newburgh, NY 12550

(845) 565-7770

www.roofvents.com

sales@roofvents.com



Active Ventilation Products

Newburgh, NY • roofvents.com

845-565-7770 • sales@roofvents.com



PART 1 General

1.1 Summary

A. Section Includes:

1. Round Back Vent, RBV-8-C2 - best used for pitched roof attic spaces as an exhaust roof vent.

B. Related Documents

1. Section 07 50 00 – Membrane Roofing
2. Section 07 60 00 – Flashing and Sheet Metal
3. Section 07 70 00 – Roof and Wall Specialties and Accessories
4. Section 07 72 00 – Roof Accessories
5. Section 07 92 00 – Joint Sealants

1.2 Reference Standards

A. Material Testing Standards:

1. Aluminum Standards:
 - a. ASTM B 209/B 209M – Specification for Aluminum and Aluminum-Alloy Sheet and Plate
2. Fastener Standards:
 - a. ASTM F593 – (National) Standard Specification for Stainless Steel Bolts, Hex Cap Screws, and Studs

B. Test Methods:

1. ASTM E330 – (National) Standard Test Method for Structural Performance of Exterior Windows, Doors, Skylights and Curtain Walls by Uniform Static Air Pressure Difference
 - a. ASTM E1886 – (National) Standard Test Method for Performance of Exterior Windows, Curtain Walls, Doors, and Impact Protective Systems Impacted by Missile(s) and Exposed to Cyclic Pressure Differentials
2. TAS 202 – (State of Florida) Criteria for Testing Impact & Non-impact Resistant Building Envelope Components Using Uniform Static Air Pressure



Active Ventilation Products

Newburgh, NY • roofvents.com

845-565-7770 • sales@roofvents.com



3. TAS 100(a) – (Miami-Dade County) Standard Test Procedure for Wind and Wind Driven Rain Resistance and/or Increased Windspeed Resistance of Soffit Ventilation Strip and Continuous or Intermittent Ventilation System Installed at the Ridge Area
4. FBC (HVHZ) – Florida Building Code (High-Velocity Hurricane Zones), Regulated by Chapter 31 of the Florida Building Code – Residential.

C. Certifications

1. Miami-Dade County, Florida Notice of Acceptance (NOA) – FBC (HVHZ), TAS 100(a):
 - a. In progress
2. Florida Building Code 2017 – ASTM E330 & TAS 202:
 - a. Certificate of Product Approval # is #FL4763-R1
 - i. Tested to design pressure of 68 psf \approx (163 MPH winds)
3. Underwriters Laboratory (UL):
 - a. Certificate Number: 20170509-R38772

1.3 Submittals

- A. Product Data: Active Ventilation Products, Inc. standard specifications and descriptive literature including:
1. Technical Specification product sheet, in PDF located at roofvents.com/drawings
 2. Technical Specification product sheet, in CAD located at roofvents.com/drawings
 3. Technical Specification product sheet, in BIM located at roofvents.com/drawings



Active Ventilation Products

Newburgh, NY • roofvents.com













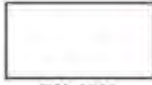

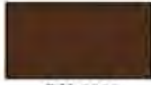





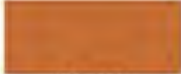



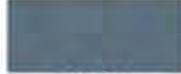

845-565-7770 • sales@roofvents.com

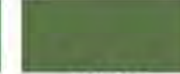
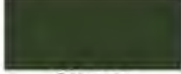

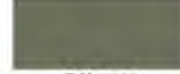
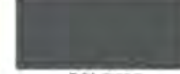
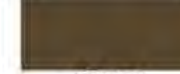
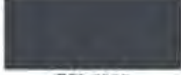
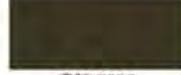
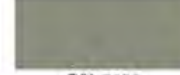
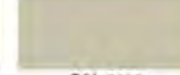
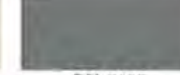
B. Color Samples: RAL color chart of selected colors located at <https://roofvents.com/color-chart-2>.

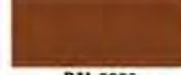
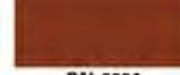
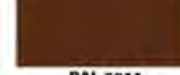
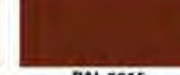
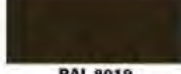
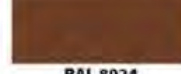
 **Active Ventilation Products, Inc.**
manufactures roof exhaust vents, roof intakes vents, solar attic fans, roof exhaust fans & more

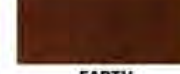
POWDER COAT COLOR CHART
Due to the inherent nature of powder coated items, we are unable to accept returns. ALL POWDER COATED SALES ARE FINAL.

Unpainted	Standard Colors				
					
ALUMINUM FINISH	GLOSS BLACK	RAL 9003 SIGNAL WHITE	RAL 6028 Pine Green	RAL 7039 Quartz Grey (Weatherwood)	RAL 8028 Terra Brown
Premium Colors					
					
RAL 1001 Beige	RAL 1013 Oyster White	RAL 1019 Grey Beige	RAL 1023 Traffic Yellow	RAL 1024 Ochre Yellow (Gold)	
					
RAL 2008 Bright Red Orange	RAL 3005 Wine Red	RAL 3007 Black Red	RAL 3009 Oxide Red (Barn Red)	RAL 3020 Traffic Red	
					
RAL 5012 Light Blue	RAL 5014 Pigeon Blue	RAL 5021 Water Blue	RAL 6002 Leaf Green	RAL 6011 Reseda Green	
					
RAL 6020 Chrome Green	RAL 6021 Pale Green	RAL 7003 Moss Grey	RAL 7012 Basalt Grey	RAL 7013 Brown Grey	
					
RAL 7015 Slate Grey	RAL 7022 Umbra Grey	RAL 7030 Stone Grey	RAL 7032 Pebble Grey	RAL 7037 Dusty Grey	
					
RAL 7040 Window Grey	RAL 8002 Signal Brown	RAL 8004 Copper Brown	RAL 8011 Nut Brown	RAL 8015 Chestnut Brown	
					
RAL 8019 Grey Brown (Burnished Slate)	RAL 8024 Beige Brown	COPPER	EARTH (Textured)	TERRA COTTA (Textured)	

Active Ventilation Products, Inc. | 111 1st Street, Newburgh, NY 12550 | www.roofvents.com | sales@roofvents.com | 1-800-756-1810





Active Ventilation Products

Newburgh, NY • roofvents.com

845-565-7770 • sales@roofvents.com

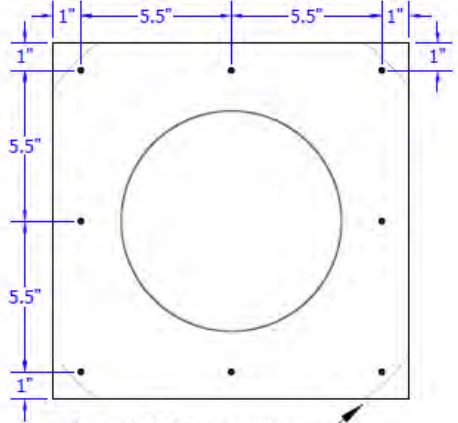
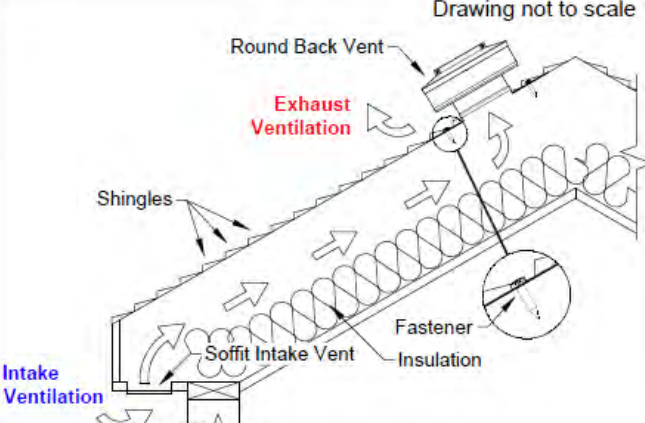

C. Manufacturer's Written Instructions

 <p>Rounded Corner option</p>	<p>Drawing not to scale</p> 
 <p>Round Back Roof Vent Model: RBV-8-C2 Diameter: 8" Collar Height: 2"</p>	<p>Round Back Roof Vent Detail & Installation Instructions</p> <ol style="list-style-type: none">1. Cut a circular hole 8" in diameter in the roof deck. Remove all debris.2. Apply sealant to the underside of the flange, then place vent down.3. Screw* vent onto roof deck, following the pattern as shown.4. Seal all seams and screws with an approved roofing sealant <p>*Recommended installation screw: Flat, Bugle or Wafer Head #10 x 1 1/2" Steel Wood Screw, Type A Point Total number of screws needed = 8 (screws not included)</p>
 <p>Active Ventilation Products, Inc. Visit us: roofvents.com Email us: sales@roofvents.com</p>	<p>1/25/2024</p>



Active Ventilation Products

Newburgh, NY • roofvents.com

845-565-7770 • sales@roofvents.com



1.4 Quality Assurance

A. Active Ventilation Products' Qualifications:

1. Active Ventilation Products has documented experience specializing in manufacturing roof vents since 1997. High-quality standards and quality control procedures followed in each phase of the manufacturing process and per the requirements of ISO 9001:2015.

B. Installer's Qualifications:

1. Installer has specialized experience of work similar to that specified for this project, following manufacturer's installation instructions.

1.5 Information Submittals

- A. Coordination Drawings: Show the roof plan drawn to scale and indicate location of model RBV-8-C2.

1.6 Delivery, Storage and Handling

- A. Delivery Requirements: Deliver materials to site in manufacturer's original, unopened containers and packaging.
- B. Store vents in a secure location protected from theft and damage.

1.7 Coordination

- A. Provide drawings that show the locations of the RBV-8-C2 to the general contractor and roofer.
- B. Provide installation instructions of the RBV-8-C2 to the general contractor and roofer.
- C. Provide this product specification to the general contractor and roofer.

1.8 Warranty

- A. Manufacturer's 5-year warranty – Written warranty provided at roofvents.com/warranties

- END OF PART 1 OF 3 -



Active Ventilation Products

Newburgh, NY • roofvents.com

845-565-7770 • sales@roofvents.com



PART 2 Products

2.1 Acceptable Manufacturers

A. Active Ventilation Products, Inc.,

311 1st Street, Newburgh, NY 12550

Website: <http://www.roofvents.com/>

Phone: 845-565-7770

E-mail: sales@roofvents.com

B. Substitutions: Not permitted

C. Request for substitutions will be considered in accordance with provisions of Section 01 60 00 - Product Requirements and notification to Active Ventilation Products, Inc.

2.2 Round Back Vent

A. Round Back Vent – Model RBV-8-C2

B. Description: RBV-8-C2 has 4 components: vent head, inner vertical louvers, collar and flat flange. The vent head is constructed with three components: a one piece spun aluminum round lid that will prevent rain and snow from entering the vent, cylinder shaped rain guard, and inner vertical louver. The cap and rain guard are beaded together to form the vent head. The cylinder shaped inner vertical louvers are attached inside the cap of the lid with screws. The inner vertical louvers will keep out insects, birds, and animals while allowing air to move through the vent with minimal resistance. The cylinder-shaped collar and flat flange are two separate components beaded together as one unit that is inseparable, otherwise known as the collar base. The vent head assembly is attached to the collar base assembly with screws to the bottom of the vent head. This allows the vent head to be removed if necessary and for easy access into the attic.



Active Ventilation Products

Newburgh, NY • roofvents.com

845-565-7770 • sales@roofvents.com



1. Material: Aluminum

a. Lid

(i) Thickness: 0.025 inch

(ii) Alloy: 1100 or 3003

b. Inner Vertical Louvers

(i) Thickness: 0.025 inch \approx Gauge no. 24 Steel thickness

(ii) Alloy: 3003-H14 Half Hard

c. Collar

(i) Thickness: 0.025 inch \approx Gauge no. 24 Steel thickness

(ii) Alloy: 3003 H14 Half Hard

d. Flange and Flashing

(i) Thickness: 0.025 inch \approx Gauge no. 24 Steel thickness

(ii) Alloy: 3003 H14 Half Hard

2. Material: Stainless Steel

a. Head Fasteners

(i) Alloy: 410 Stainless Steel

(ii) Size: #6 x 3/8"

(iii) Head: Square Drive

(iv) Point: AB Point, Self-Tapping

b. Collar Fasteners

(i) Alloy: 410 Stainless Steel

(ii) Size: #8 x 1/2"

(iii) Head: Hex

(iv) Point: Self-Tapping



Active Ventilation Products

Newburgh, NY • roofvents.com

845-565-7770 • sales@roofvents.com



3. Size:
- a. Inside diameter: 8 inches
 - b. Width of Vent Head: 11.25 inches
 - c. Height of Vent Head: 3.125 inches
 - d. Collar Height: 2 inches
 - e. Flange: 13 inches (square or rounded corners)
 - f. Flashing: 2.5 inches
 - g. Inner vertical louver: 2.5-inch height
 - h. Opening between blades of Inner Vertical Louver: 0.125 inch
 - i. Total height including collar: 5.125 inches

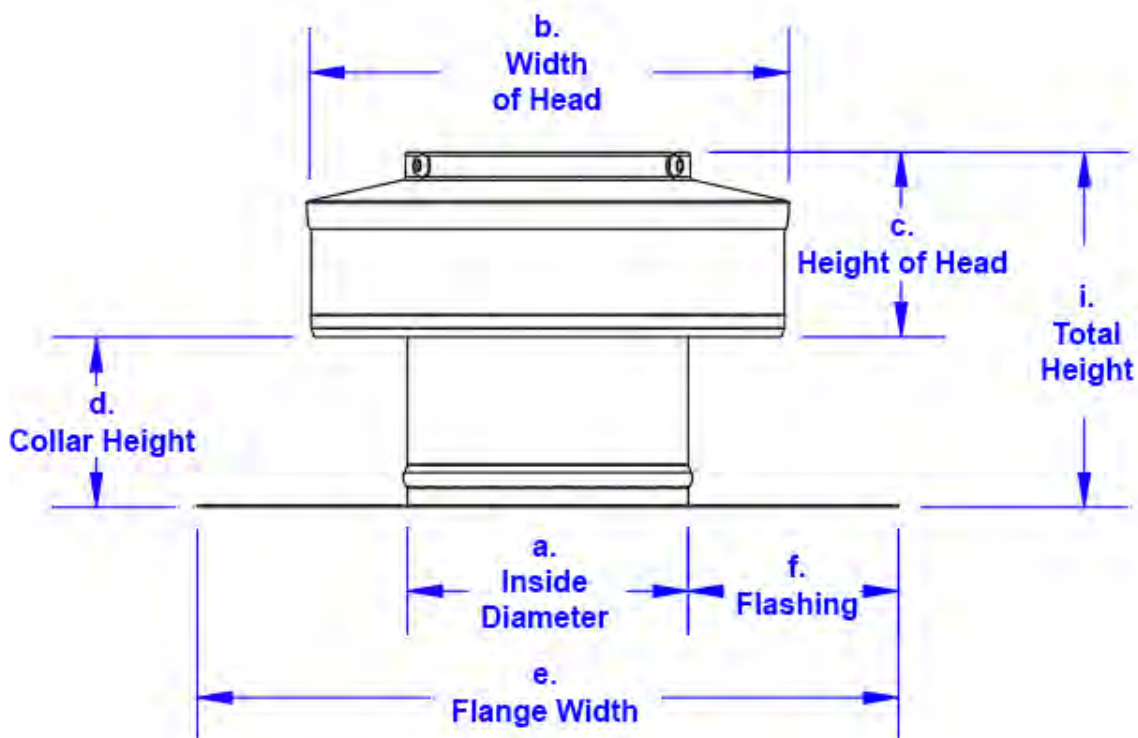



Active Ventilation Products

Newburgh, NY • roofvents.com

845-565-7770 • sales@roofvents.com



- j. Net Free Area: 50 square inches
- k. Net Free Area: 0.35 square feet
- l. Minimum Pitch Capacity: 3/12
- m. Maximum Pitch Capacity: 12/12
- n. Recommended use for: 3/12 to 7/12
 - (i) If used for higher pitches (8/12 – 12/12), the installer needs to use a guide wire.
- 4. Standard Finish: Mill finished aluminum
- 5. Optional Color Finish: Selected RAL colors located on roofvents.com/color-chart-2
 - a. Paint is applied by using an electrostatic powder coating process.
- 6. Operation: Gravity, static, passive (non-motorized)



- END OF PART 2 OF 3 -



Active Ventilation Products

Newburgh, NY • roofvents.com

845-565-7770 • sales@roofvents.com



PART 3 Execution

3.1 Ventilation Requirement

- A. Application: One Vent per square foot print of the attic floor
 - 1. Venting Rule 1:150: RBV-8-C2 = 104 square feet
 - 2. Venting Rule 1:300: RBV-8-C2 = 208 square feet
- B. Refer to the Venting Requirements Calculator on <https://roofvents.com/active-ventilation-products-attic-vent-calculator> to calculate the total quantity of RBV-8-C2 needed per square foot.
- C. Net Free Area per RBV-8-C2 = 50 square inch, (0.35 square feet)

3.2 Examination

- A. Examine site conditions and verify that structural supports and openings are properly sized, prepared and ready to receive the Round Back Vent model RBV-8-C2.
 - 1. Proceed with installation only after unacceptable conditions have been remedied.

3.3 Preparation

- A. From the building plans locate the placement of Round Back Vent RBV-8-C2 on the roof.
- B. Prepare roof deck to receive the RBV-8-C2 with the accessories in accordance with the written installation instructions.

3.4 Pitched Roof Detailed Installation



Active Ventilation Products

Newburgh, NY • roofvents.com

845-565-7770 • sales@roofvents.com



Step 1:

Turn the vent upside down and make a cardboard template from the flange. The template should be the same size as the flange with the hole in the middle.



Step 2:

Using the template, trace the square and circle onto the roof as shown.



Step 3:

Remove cardboard template to show the square and circle pattern.



Step 4:

Using a reciprocating saw cut out a hole in the roof deck and remove all debris.



Step 5:

Put roofing sealant on the underside along the bottom edge of flange as shown.

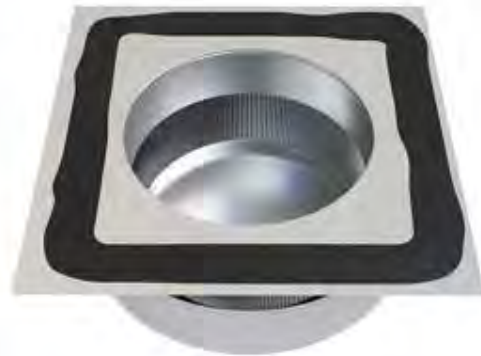



Active Ventilation Products

Newburgh, NY • roofvents.com

845-565-7770 • sales@roofvents.com



Step 6:

Slide vent underneath the shingles stay within the square outline.



Step 7A:

With the vent in place secure the flange to the shingle roof using a screw gun or drill



7B:

Required screw: #10 x 1.5" steel sheet metal screw
Total number of screws required = 12

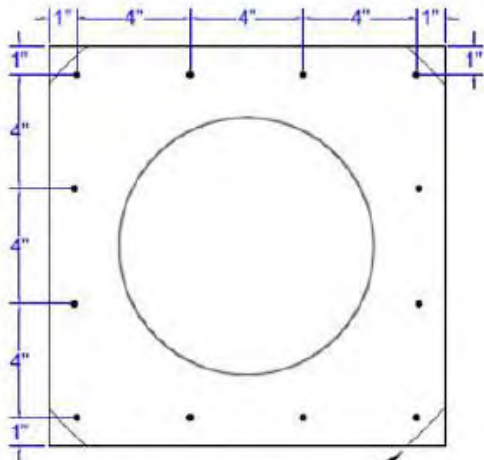

Step 8:

This is how the Round Back Vent should look when finished





Active Ventilation Products

Newburgh, NY • roofvents.com

845-565-7770 • sales@roofvents.com



A. Accessories to be provided by installer:

1. Sealant: Installer provides sealant recommended for the application and type by roofing manufacturer or construction material manufacturer. Comply with requirements of Section 07 92 00 – Joint Sealants.
2. Fasteners: Installer provides corrosion resistant Flat, Bugle or Wafer Head #10 x 1 ½” Sheet Metal Screws, Type A Point.

3.5 Cleanup

- ### A. Upon completion, remove surplus materials, rubbish, tools and equipment.

- END OF PART 3 OF 3 -