

Active Ventilation Products, Inc.

Website: roofvents.com

Email: sales@roofvents.com

Specification Sheet

1/1/2023

Insulated Roof Curb Model: RC-10-H6-Ins ID: 12" OD: 13"

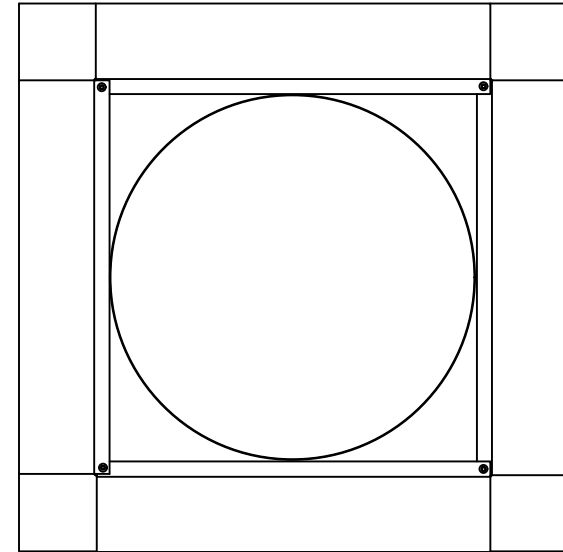
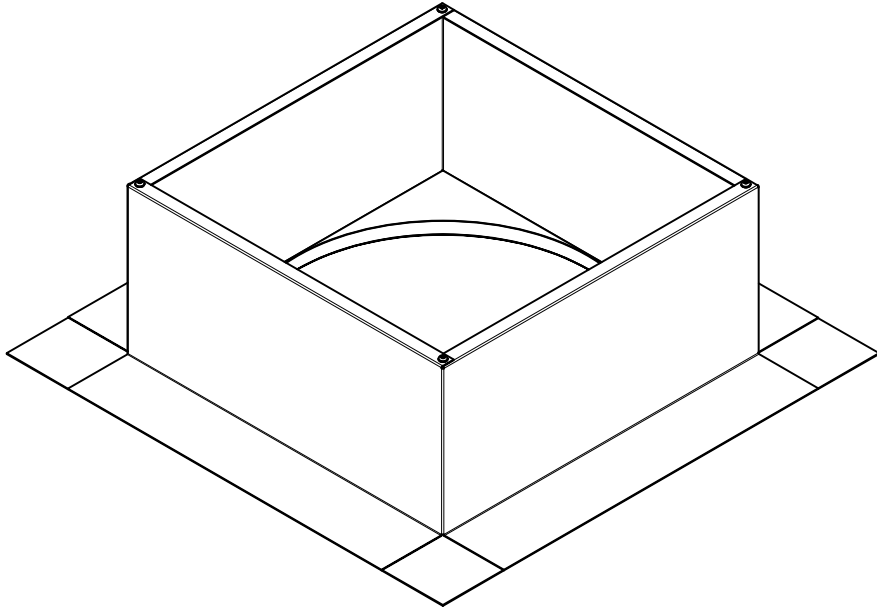

- Aluminum Alloy 3003-H14
- Thickness = 0.025" ± 0.005
- Tolerance = ± .25 (1/4")

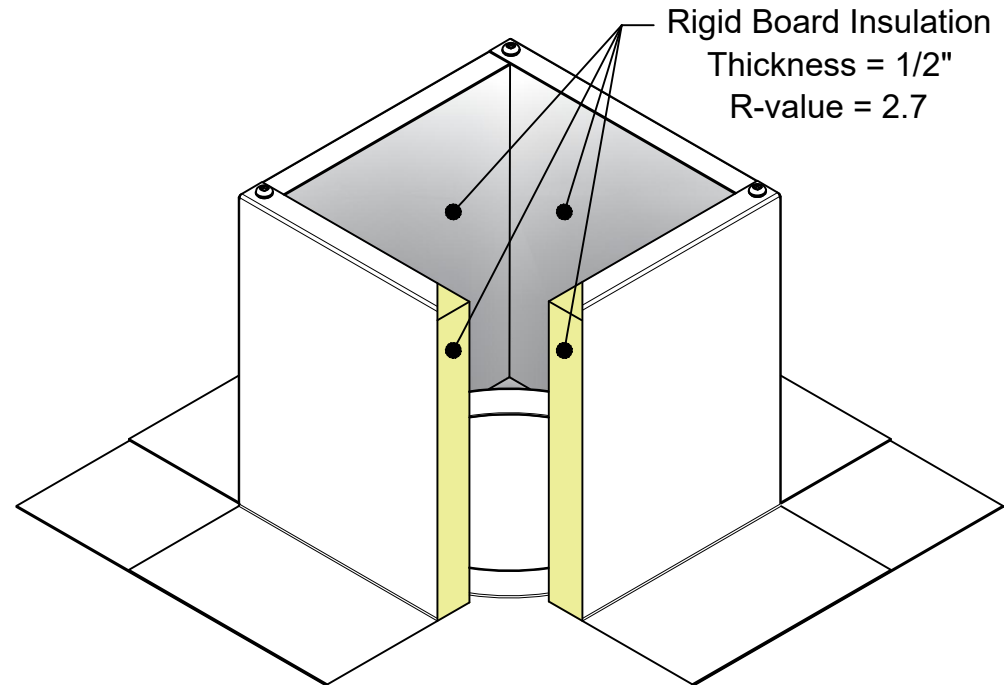

Model is Not to Scale