



Active Ventilation Products, Inc.

Website: roofvents.com

Email: sales@roofvents.com

Specification Sheet

9/6/2023

Insulated Roof Curb Model: RC-20-H8-Ins ID: 21" OD: 23"

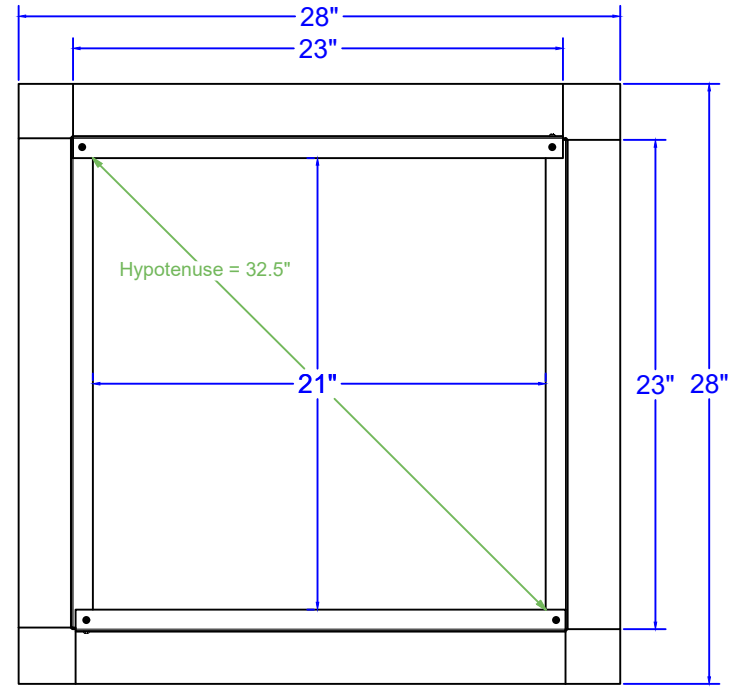
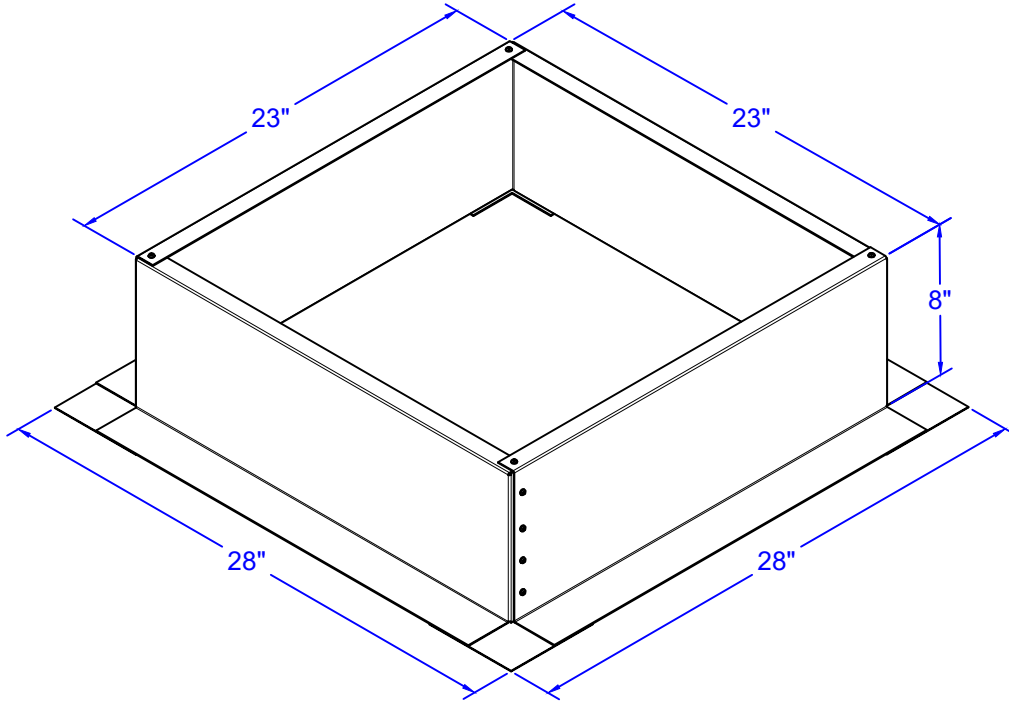

- Aluminum Alloy 3003-H14
- Thickness = 0.040" ± 0.005
- Tolerance = ± .25 (1/4")

