

Screw Pattern (Symmetrical for all sides)

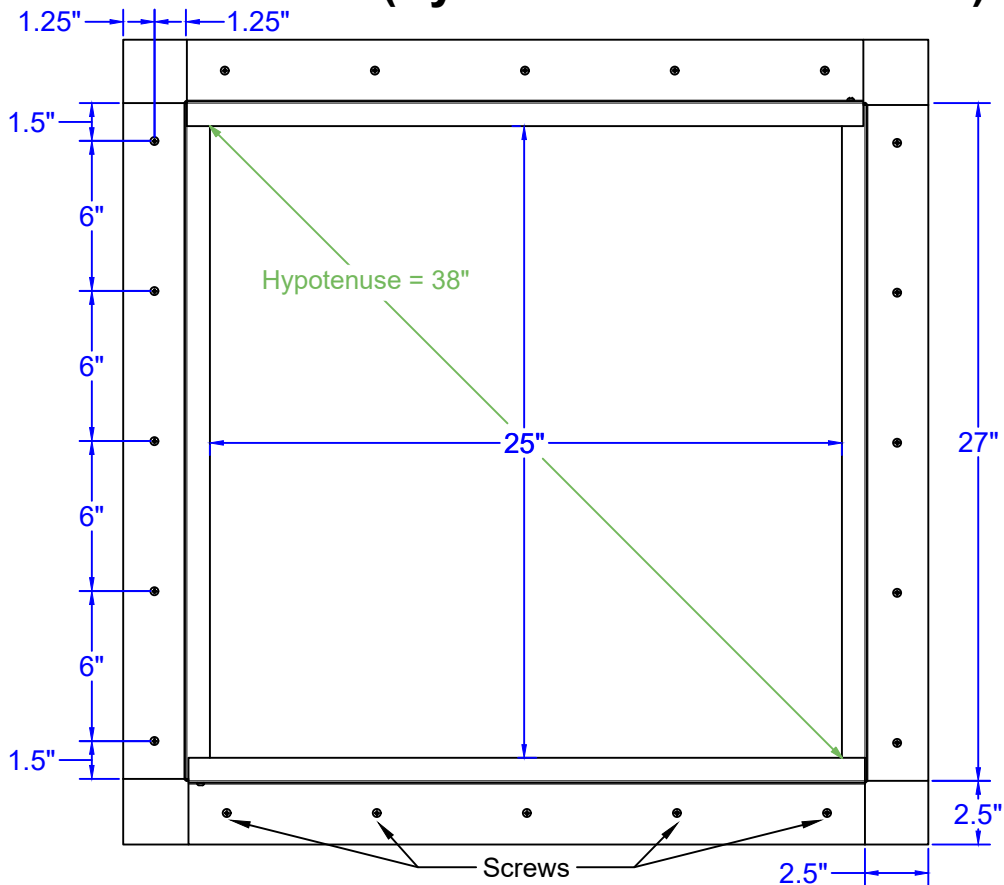

Roof Curb Flashing Detail

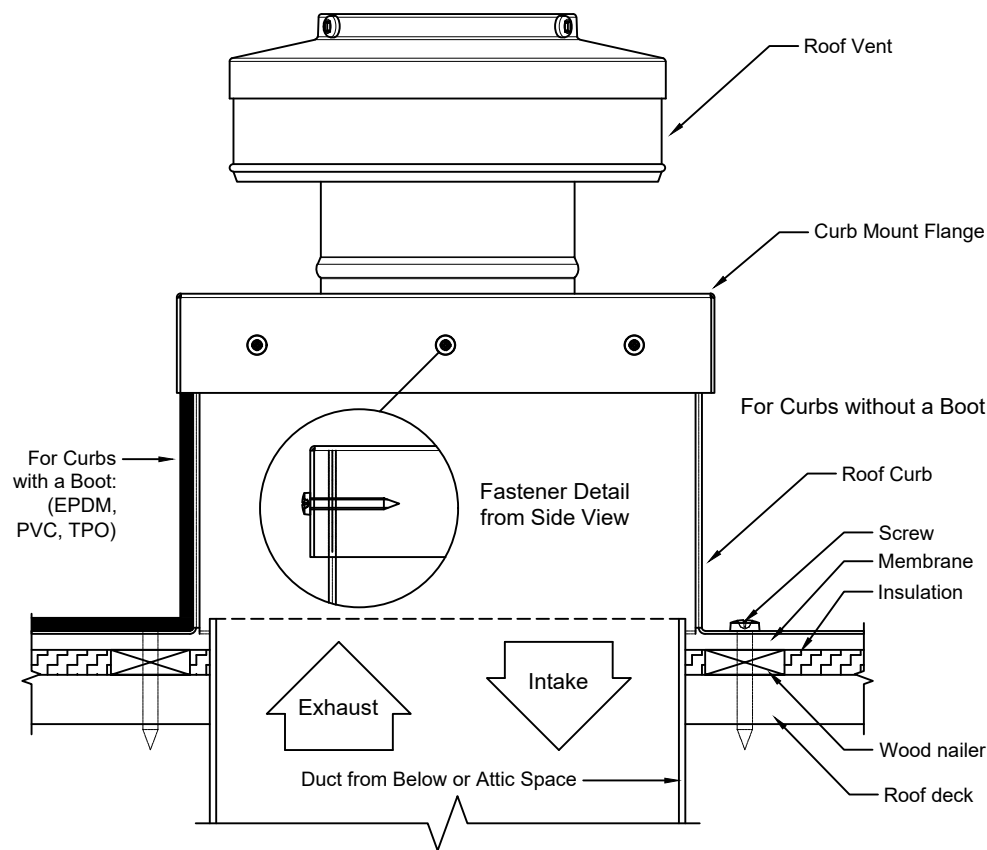

- Aluminum Alloy 3003-H14
- Thickness = 0.040" ± 0.005
- Tolerance = ± .25 (1/4")

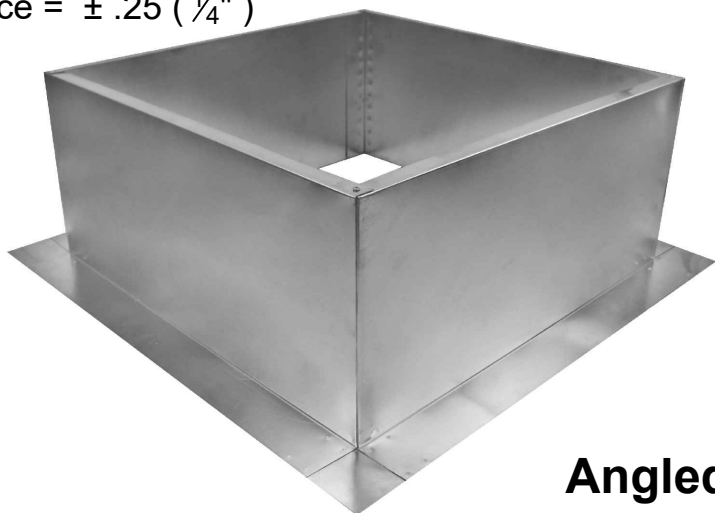

Angled View

Roof Curb Installation Instructions

1. Cut a square or round hole 25" in diameter in the roof deck.
2. Total number of screws needed for flange = 20
3. *Recommended installation screw: Flat, Bugle or Wafer Head #10 x 1 1/2" Sheet Metal Screw, Type A Point*
4. Flash roof curb onto deck according to specifications of the membrane manufacturer.
5. Screws not included.

Roof Curb Model: RC-24-H12

Inside Opening: 25", Outside Length & Width: 27", Height: 12"

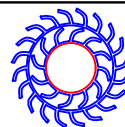

Active Ventilation Products, Inc.

Website: roofvents.com

Email: sales@roofvents.com

11/17/2023