



Active Ventilation Products

Newburgh, NY • roofvents.com

845-565-7770 • sales@roofvents.com



Manufactured Roof Curbs 07 72 13

Roof Curb 3-Part Spec – Model: *RC-3-H8*

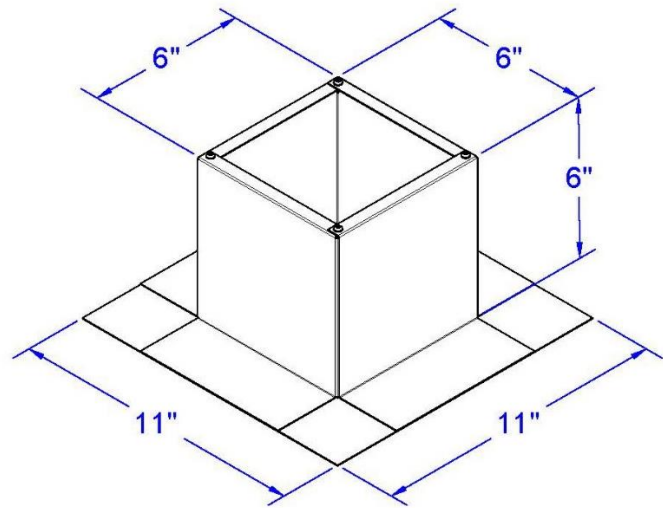

PART 1 General

1.1 Summary

A. Section Includes:

1. Roof Curb, RC-3-H8 acts as an extension from the roof deck, providing a platform to a roof vent, roof exhaust fan or solar attic fan.

1.2 References

A. Material Testing Standards & Test Methods:

1. ASTM B 209/B 209M – Specification for Aluminum and Aluminum-Alloy Sheet and Plate
2. ASTM F593 – (National) Standard Specification for Stainless Steel Bolts, Hex Cap Screws, and Studs
3. ASTM E330 – (National) Standard Test Method for Structural Performance of Exterior Windows, Doors, Skylights and Curtain Walls by Uniform Static Air Pressure Difference



Active Ventilation Products

Newburgh, NY • roofvents.com

845-565-7770 • sales@roofvents.com



4. ASTM E1886 – (National) Standard Test Method for Performance of Exterior Windows, Curtain Walls, Doors, and Impact Protective Systems Impacted by Missile(s) and Exposed to Cyclic Pressure Differentials
5. TAS 202 – (State of Florida) Criteria for Testing Impact & Non-impact Resistant Building Envelope Components Using Uniform Static Air Pressure
6. FBC (HVHZ) – Florida Building Code (High-Velocity Hurricane Zones), Regulated by Chapter 31 of the Florida Building Code – Residential.

B. Certifications

1. Florida Building Code 2017 – ASTM E330 & TAS 202: In progress
2. Miami-Dade County: In progress
3. Underwriters Laboratory (UL): In progress
4. Texas Department of Insurance: In progress

1.3 Submittals

A. Product Data: Active Ventilation Products, Inc. standard specifications and descriptive literature including:

1. Technical Specification product sheet, in PDF/CAD/BIM located at roofvents.com/drawings

B. Manufacturer's Written Instructions: roofvents.com/avp-installation-guides/

C. Coordination Drawings: Show the roof plan drawn to scale and indicate location of model RC-3-H8. See *Placement Instructions* on roofvents.com/placement-instructions

1.4 Warranty

A. Manufacturer's 5-year warranty – Written warranty provided at roofvents.com/warranties

- END OF PART 1 OF 3 -



Active Ventilation Products

Newburgh, NY • roofvents.com

845-565-7770 • sales@roofvents.com



PART 2 Products

2.1 Manufacturers

A. Acceptable Manufacturers: Active Ventilation Products, Inc., 311 1st Street, Newburgh, NY 12550, **Substitutions not permitted.**

2.2 Roof Curb - Model RC-3-H8, H8 Series

A. Material for Roof Curb: Aluminum

1. Box - Thickness: 0.025 inch, Alloy: 3003 H14 Half Hard
2. Flange: Thickness: 0.025 inch, Alloy: 3003 H14 Half Hard

B. Material for Fasteners: 410 Stainless Steel

1. For Top Four Corners: Quantity: 4, #6 x 3/8" Square Drive AB Point, Self-Tapping Screw

C. RC-3-H8 Specifications:

- a. Inside opening: 5 inches
 - b. Width of Box: 6 inches
 - c. Width of Flange: 11 inches
 - d. Height of Curb: 8 inches
 - e. Hypotenuse (Diagonal Length of Opening): 7 inches
 - f. Minimum Pitch Capacity: 0/12
 - g. Maximum Pitch Capacity: 12/12
 - h. Recommended use for: 0/12, 1/12 or 2/12 pitch
 - (i) If 3/12 or higher, the Roof Curb must be leveled out with a wood wedge or use a Pitched Roof Curb.
2. Standard Finish: Mill finished aluminum
 - (i) Powder Coating available (see roofvents.com/color-chart-2/)



Active Ventilation Products

Newburgh, NY • roofvents.com

845-565-7770 • sales@roofvents.com



D. Operation:

1. Roof penetration used in conjunction with Curb Mounted Gravity Ventilators or Powered Fans. Vibration isolation for HVAC machinery. Increases energy efficiency, and reduces condensation of roof.

- END OF PART 2 OF 3 -

PART 3 Execution

3.1 Examination

- A. Examine site conditions and verify that structural supports and openings are properly sized, prepared and ready to receive the Roof Curb model RC-3-H8.
 1. Proceed with installation only after unacceptable conditions have been remedied.

3.2 Preparation

- A. From the building plans locate the placement of Roof Curb RC-3-H8 on the roof.
- B. Prepare roof deck to receive the RC-3-H8 with the accessories in accordance with the written installation instructions.

3.3 Flat Roof Installation

- A. See roofvents.com/avp-installation-guides/ for details:
- B. Accessories to be provided by installer:
 1. Sealant: Installer provides sealant recommended for the application and type by roofing manufacturer or construction material manufacturer. Comply with requirements of Section 07 92 00 – Joint Sealants.
 2. Fasteners: Installer provides corrosion resistant Flat, Bugle or Wafer Head #10 x 1 ½” Sheet Metal Screws, Type A Point.

3.4 Cleanup

- A. Upon completion, remove surplus materials, rubbish, tools and equipment.

- END OF PART 3 OF 3 -