



Roof Curb

Model Number: RC-4-H12

Inside Throat Diameter: 6" | Outside Length & Width: 7" | Height: 12"



- A metal roof curb for roof vents or attic fans
- Preassembled to reduce installation time
- For EPDM, PVC and TPO roofs
- Aluminum Alloy 3003-H14, thickness 0.025" (± 0.005 ")
- Lighter and more versatile than wooden roof curbs
- Allows for easy access to the attic or plenum below
- 12" tall, 7" x 7" wide and 6" diameter throat in the base
- 5 year warranty

Dimensions & Specifications

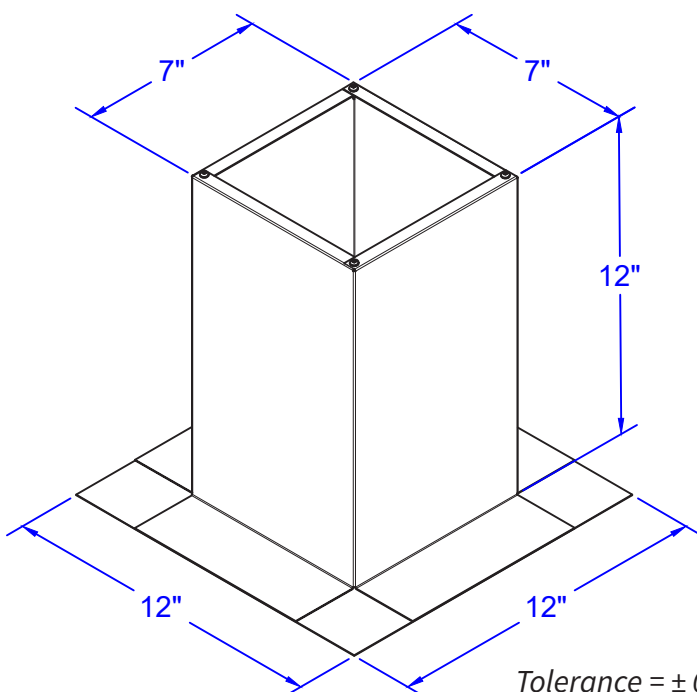

Tolerance = ± 0.25 "

