



## Roof Curb

**Model Number: RC-5-H8**

*Inside Throat Diameter: 7" | Outside Length & Width: 8" | Height: 8"*



- A metal roof curb for roof vents or attic fans
- Preassembled to reduce installation time
- For EPDM, PVC and TPO roofs
- Aluminum Alloy 3003-H14, thickness 0.025" ( $\pm 0.005$ " )
- Lighter and more versatile than wooden roof curbs
- Allows for easy access to the attic or plenum below
- 8" tall, 8" x 8" wide and 7" diameter throat in the base
- 5 year warranty

### Dimensions & Specifications

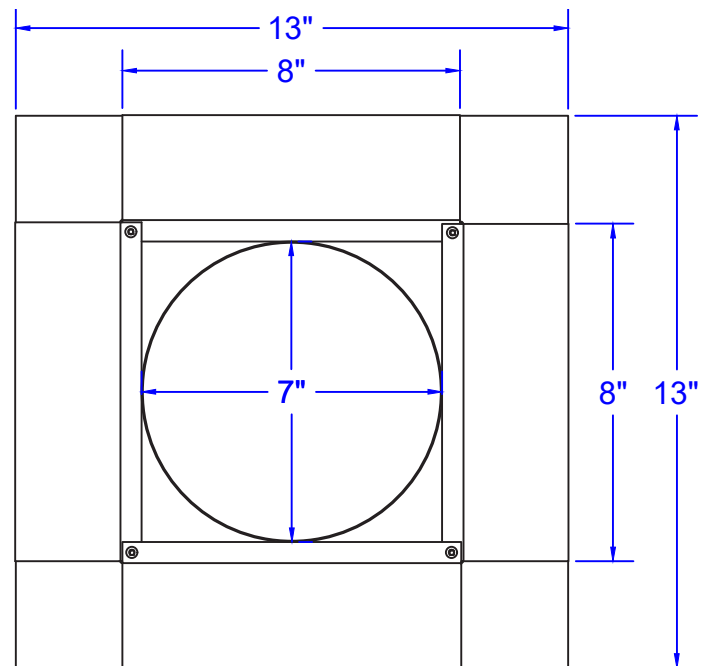
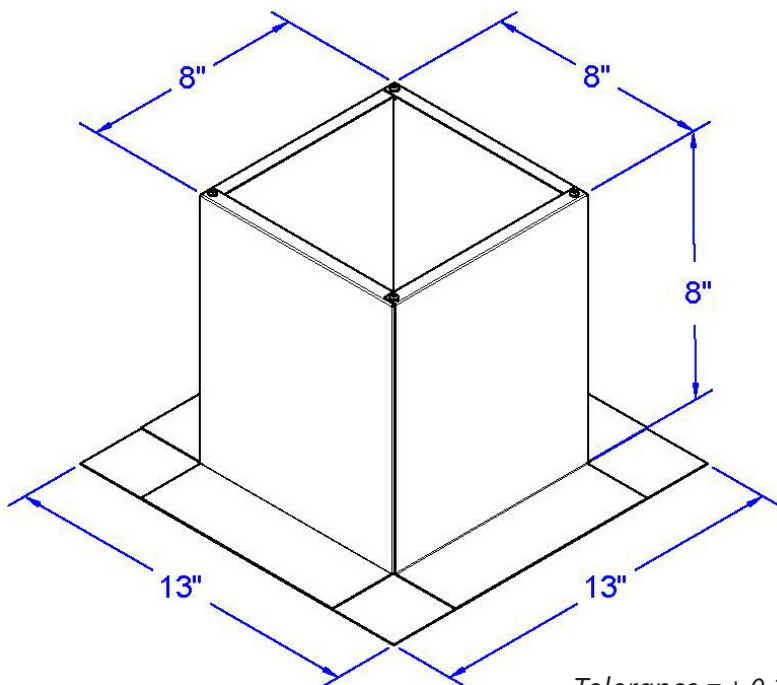

Tolerance =  $\pm 0.25$ "