

Top View

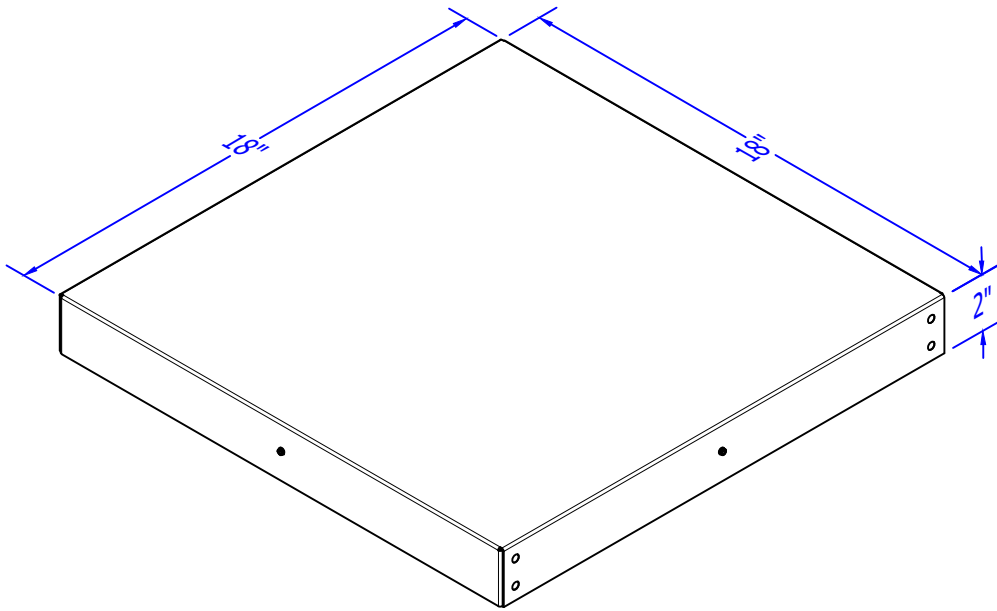

Roof Curb Cap Flashing Detail

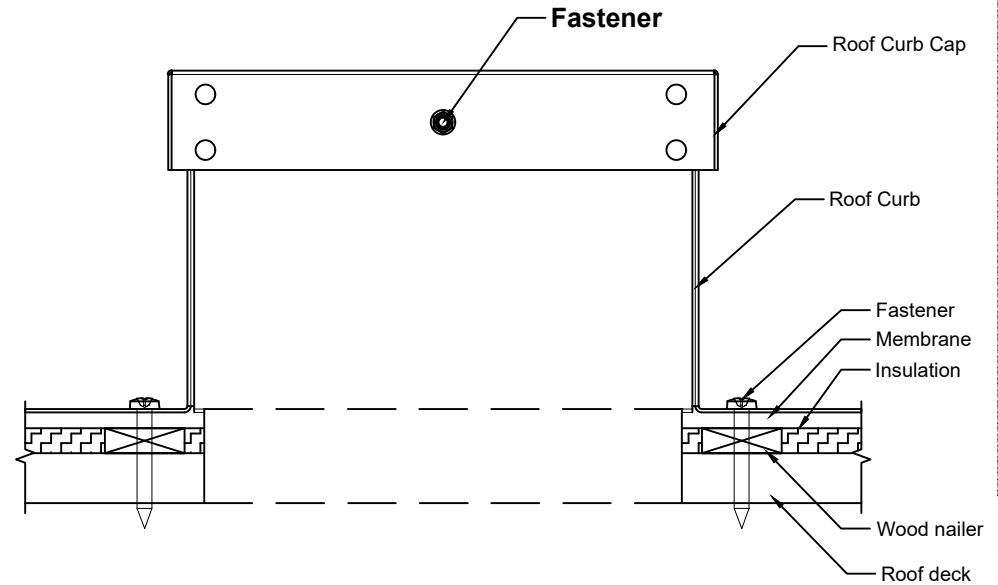

Side View

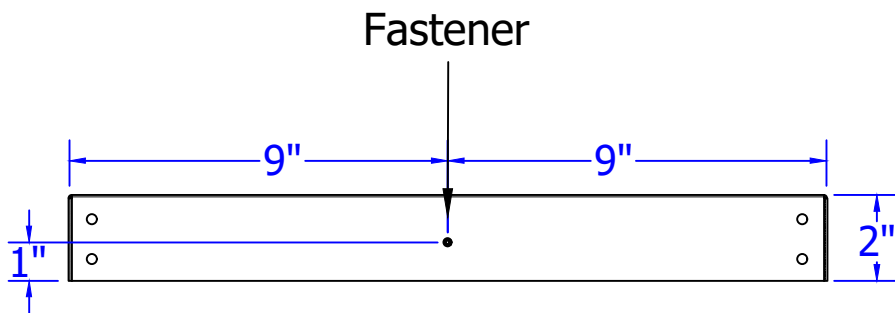

Roof Curb Cap Installation Instructions

1. Optional: Place sealant over lip.
2. Center cap over roof curb.
3. Attach cap to roof curb using Self Tapping Sheet Metal Screw #8 x 1" on each side.
4. Total number of screws needed = 4

Note: Screws and Roof curb not included.

Roof Curb Cap

Model: RC-Cap-14

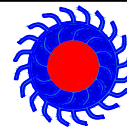

Active Ventilation Products, Inc.

Website: roofvents.com Email: sales@roofvents.com

12/7/2021