

### Angled View

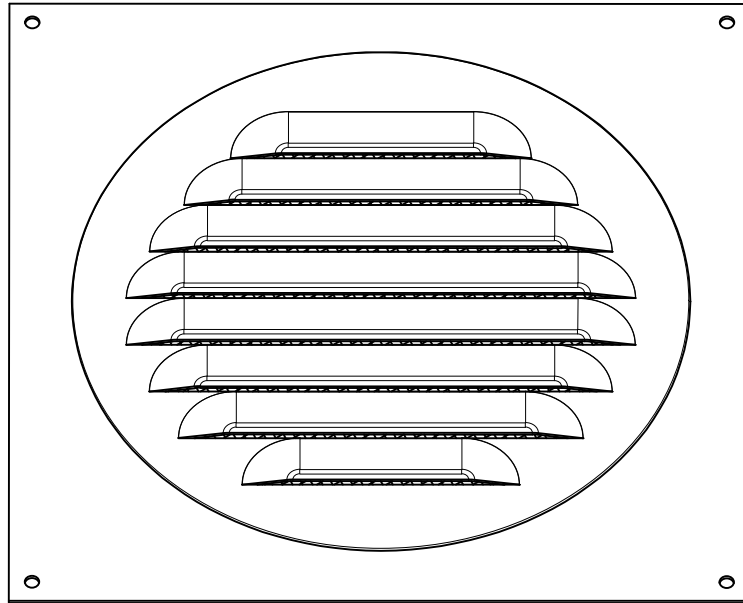

- Net Free Area (NFA) = 5.49 sq in

### Side View

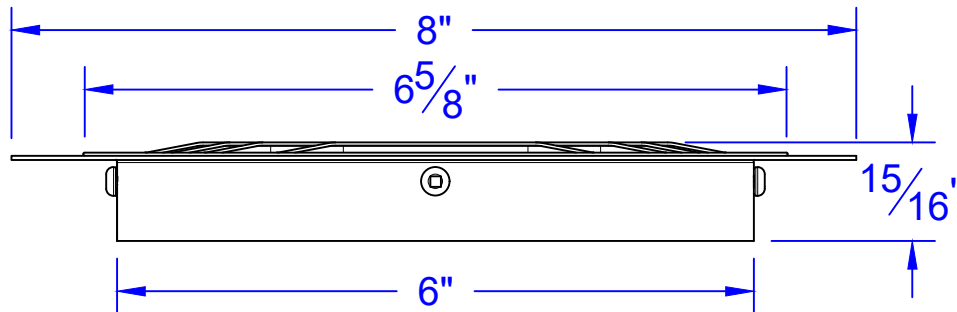

### Round Soffit Vent Flashing Detail

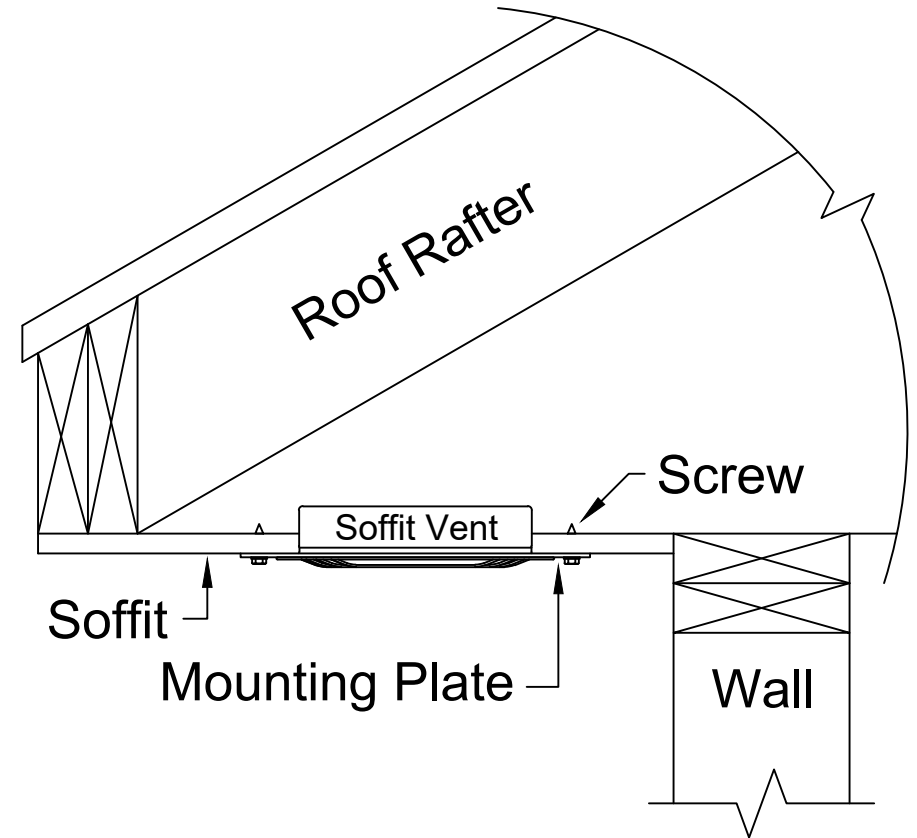

### Round Soffit Vent Installation Instructions

1. Cut a 6" hole into the soffit using a hole saw.
2. Insert the vent into the hole in the soffit.
3. Attach the mounting plate onto the soffit using 4 screws to secure the soffit vent in place.

\* Make sure the opening of the louvers are facing the house  
 \*\* Recommended Screw: #8 x 1" Sheet Metal Screw  
 (Screws not included)