



## Square Roof Curb

**Model Number: SRC-16-H8 | Fits Vent or Fan with Base  $\geq 19\frac{1}{2}$ "**

**Inside Opening: 17" | Outside Length & Width: 19" | Height: 8"**



- A metal Square Roof Curb for roof vents, attic fans, or HVAC assemblies
- Preassembled to reduce installation time
- Used on EPDM, PVC and TPO roofs
- Manufactured of .040 thick Aluminum
- Lighter and more fireproof than wooden roof curbs
- Allows for easy access to the attic or plenum below



Side

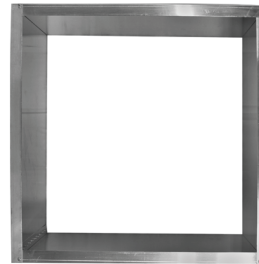

Top View

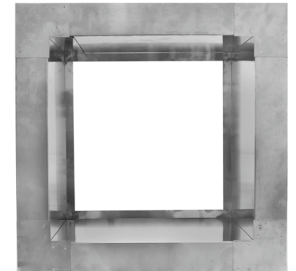

Bottom View

## Dimensions & Specifications

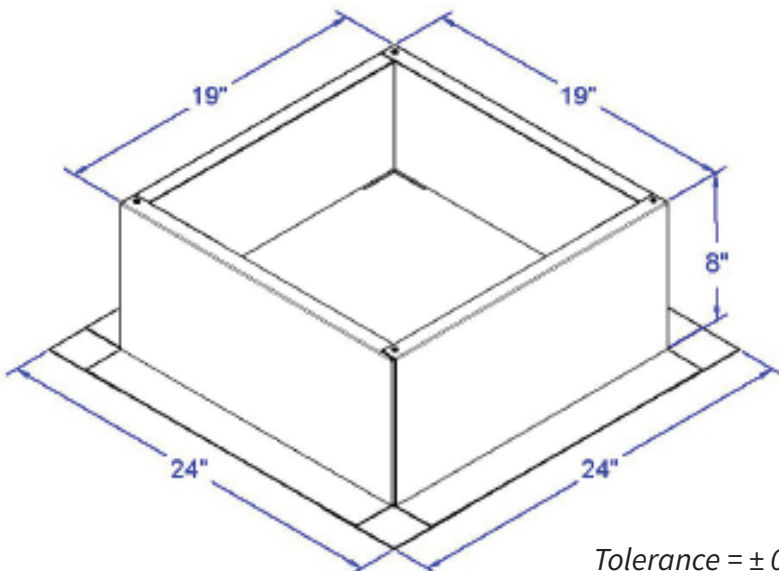

Tolerance =  $\pm 0.25$ "

