

Insulated Square Roof Curb

Model Number: SRC-18-H8-Ins

Inside Opening: 19" | Outside Length & Width: 21" | Height: 8"



- A metal roof curb for roof vents or attic fans
- Insulation adds a protective layer from outside weather
- R-6, 1" thick foil faced polyiso board insulation
- Preassembled to reduce installation time
- Only for EPDM, PVC and TPO roofs
- Aluminum Alloy 3003-H14, thickness 0.040" (± 0.005 ")
- 8" tall, 21" square OD, and 19" inside opening in base
- 5 year warranty

Dimensions & Specifications

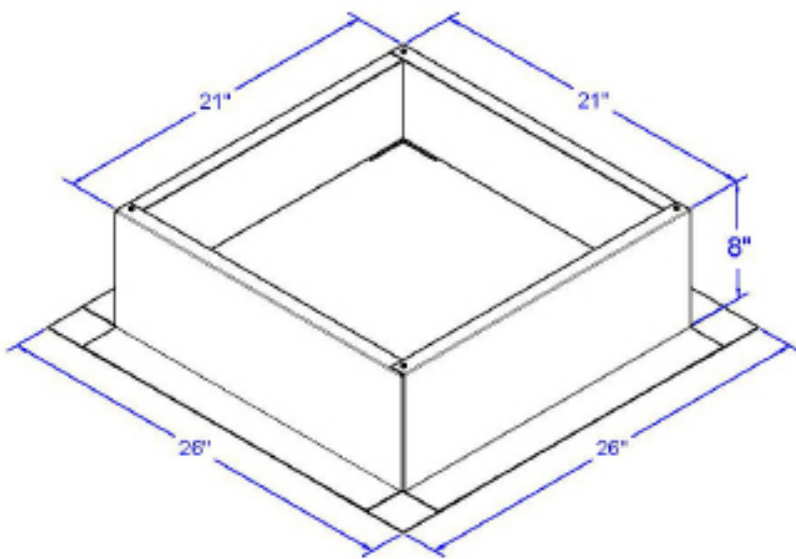

Tolerance = ± 0.25 "

