

Insulated Square Roof Curb

Model Number: SRC-7-H8-Ins

Inside Throat Diameter: 9" | Outside Length & Width: 10" | Height: 8"



- Aluminum roof curb for roof vents or attic fans
- Insulation adds a protective layer from outside weather
- R-2.7, 0.5" thick foil faced polyiso board insulation
- Preassembled to reduce installation time
- Only for EPDM, PVC and TPO roofs
- Aluminum Alloy 3003-H14, thickness 0.025" (± 0.005 ")
- 8" tall, 10" square OD, and 9" diameter throat in base
- 5 year warranty

Dimensions & Specifications

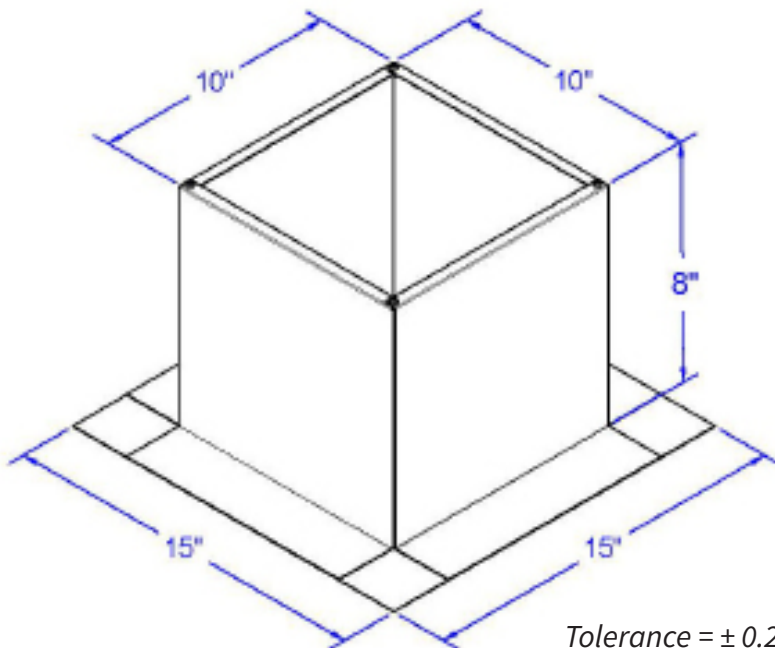

Tolerance = ± 0.25 "

