

Flashing Detail & Instructions

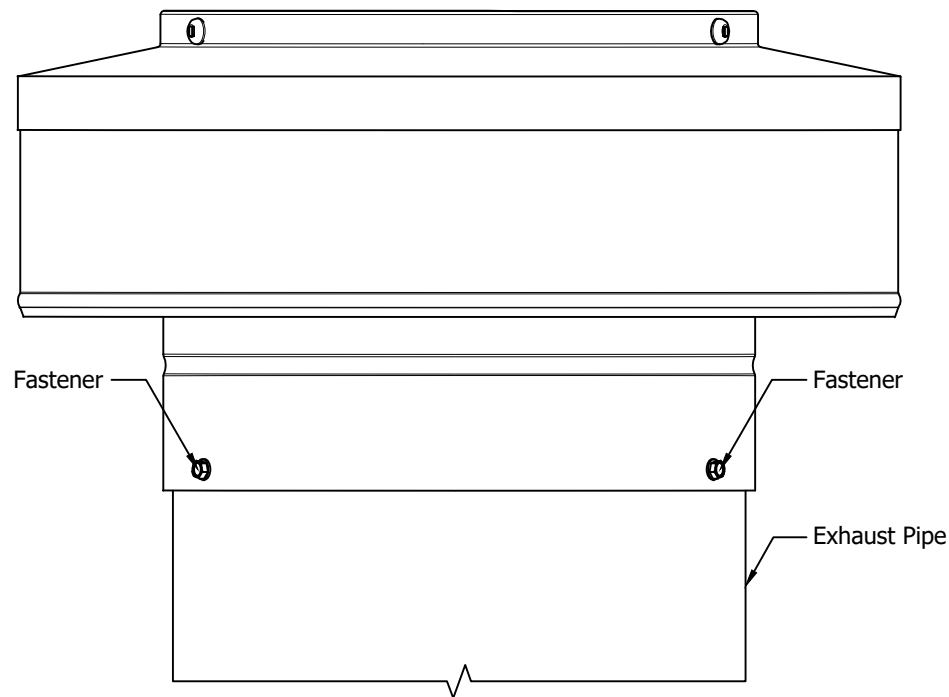

1. Slide the Vent Pipe Cap over the existing pipe.
2. Observe the screws located on top of the vent. Use this as a pattern to attach the vent to the pipe.
3. To secure the vent, attach the vent to the pipe using a #8 self-tapping sheet metal screw.
4. Total number of screws needed = 4
5. *Recommended installation screw:*
#8 x 1/2" Sheet Metal Screw
6. Screws not included.

* All Aluminum Construction, Thickness = 0.025" [0.635 mm]

