



Roof Curb

Model Number: RC-10-H8

Inside Throat Diameter: 12" | Outside Length & Width: 13" | Height: 8"



- A metal roof curb for roof vents or attic fans
- Preassembled to reduce installation time
- For EPDM, PVC and TPO roofs
- Aluminum Alloy 3003-H14, thickness 0.025" (± 0.005 ")
- Lighter and more versatile than wooden roof curbs
- Allows for easy access to the attic or plenum below
- 8" tall, 13" x 13" wide and 12" diameter throat in the base
- 5 year warranty

Dimensions & Specifications

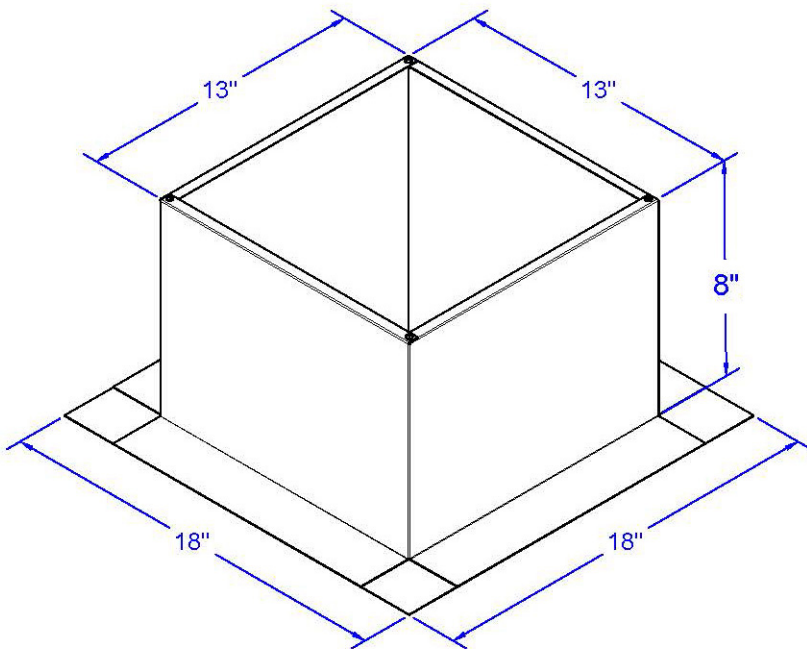

Tolerance = ± 0.25 "

