

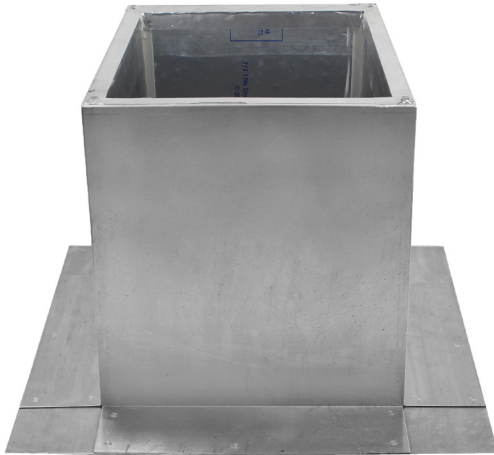

## Insulated Roof Curb

**Model Number: RC-5-H8-Ins**

*Inside Throat Diameter: 7" | Outside Length & Width: 8" | Height: 8"*



- Aluminum roof curb for roof vents or attic fans
- Insulation adds a protective layer from outside weather
- R-2.7, 0.5" thick foil faced polyiso board insulation
- Preassembled to reduce installation time
- Only for EPDM, PVC and TPO roofs
- Aluminum Alloy 3003-H14, thickness 0.025" ( $\pm 0.005$ " )
- 8" tall, 8" square OD, and 7" diameter throat in the base
- 5 year warranty

### Dimensions & Specifications

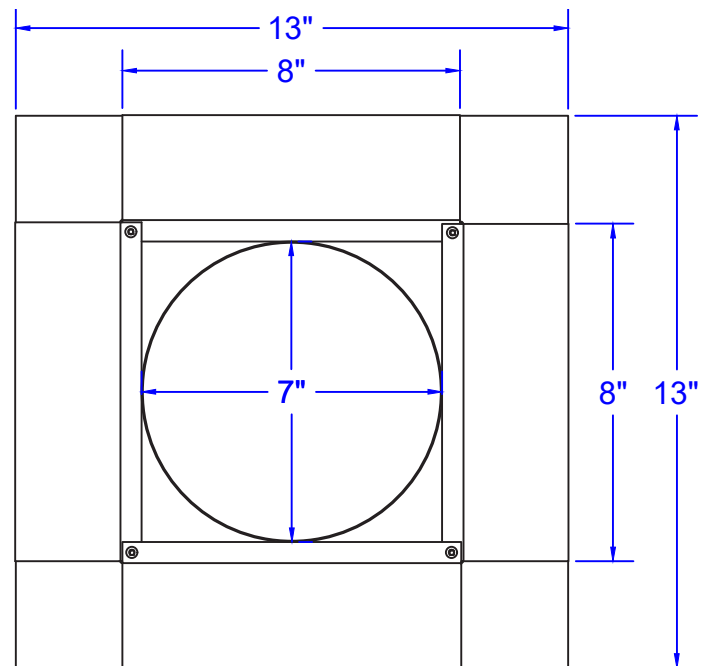
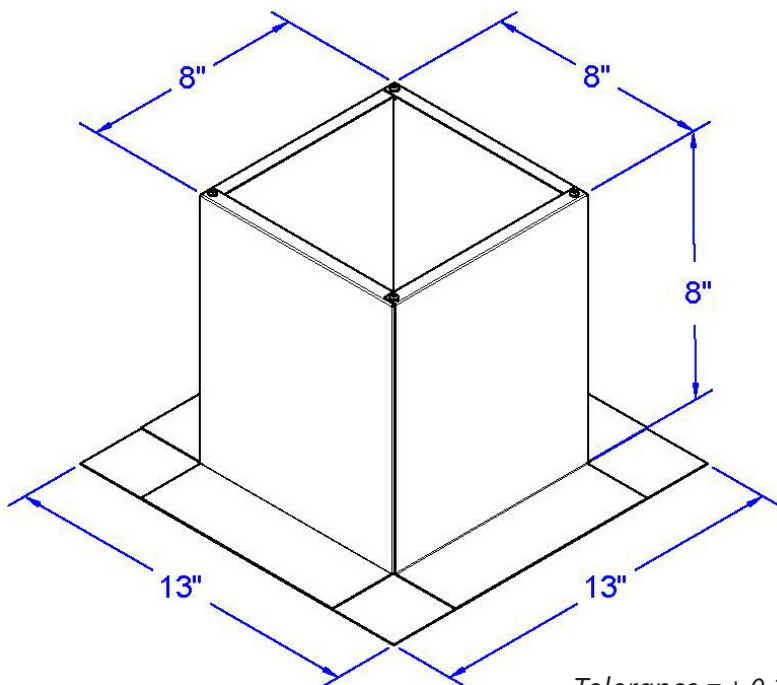

Tolerance =  $\pm 0.25$ "