

Active Ventilation Products, Inc.

Website: roofvents.com

Email: sales@roofvents.com

Specification Sheet

10/24/2022

Aura Solar Fan Retrofit Model: ASF-8-RF Diameter: 8"

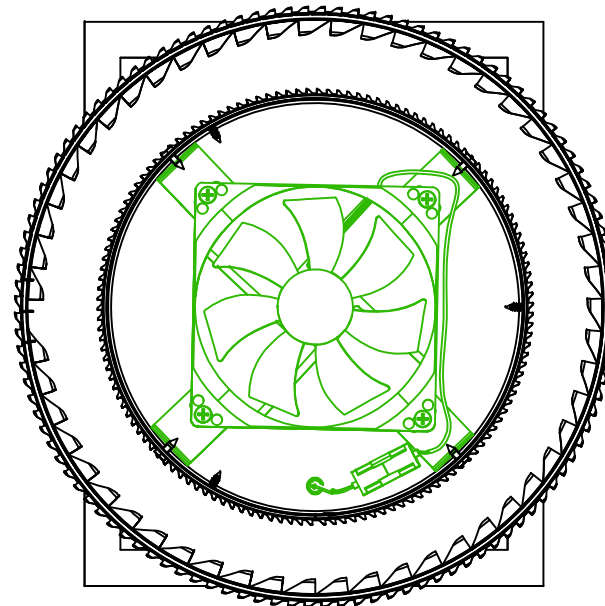
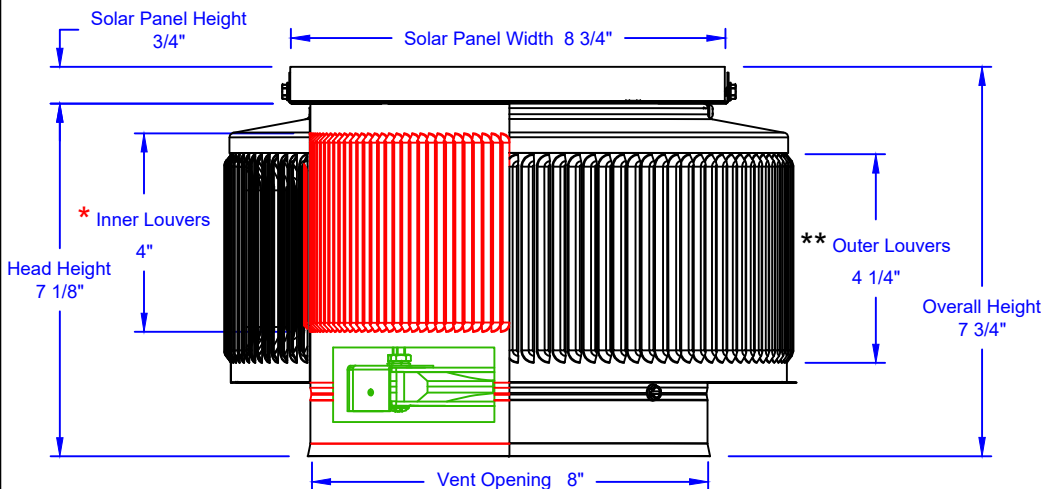

- Aluminum Alloy 3000 Series
- Minimum Thickness = 0.025"

- * Inside Louver Opening = 1/8"
- ** Outside Louver Opening = 1/4"