



Active Ventilation Products, Inc.

Website: roofvents.com

Email: sales@roofvents.com

Specification Sheet

8/4/2022

Insulated Roof Curb Model: RC-14-H6-Ins ID: 15" OD: 17"

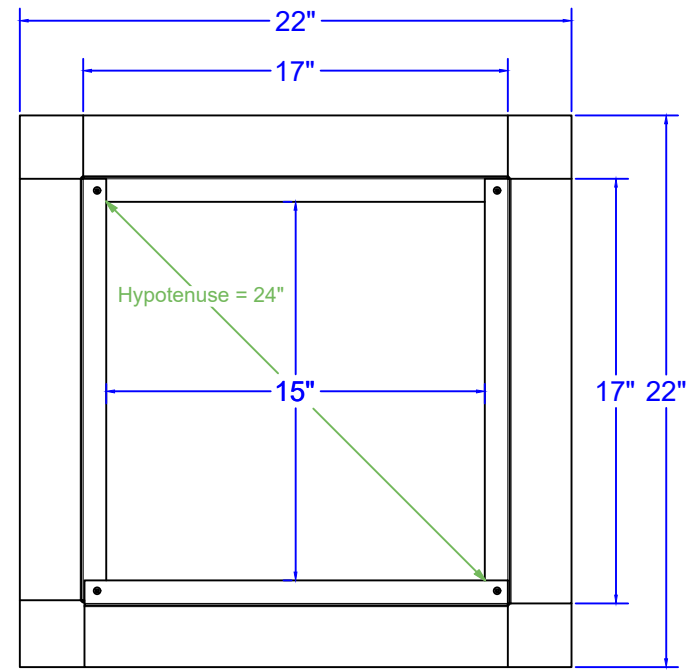
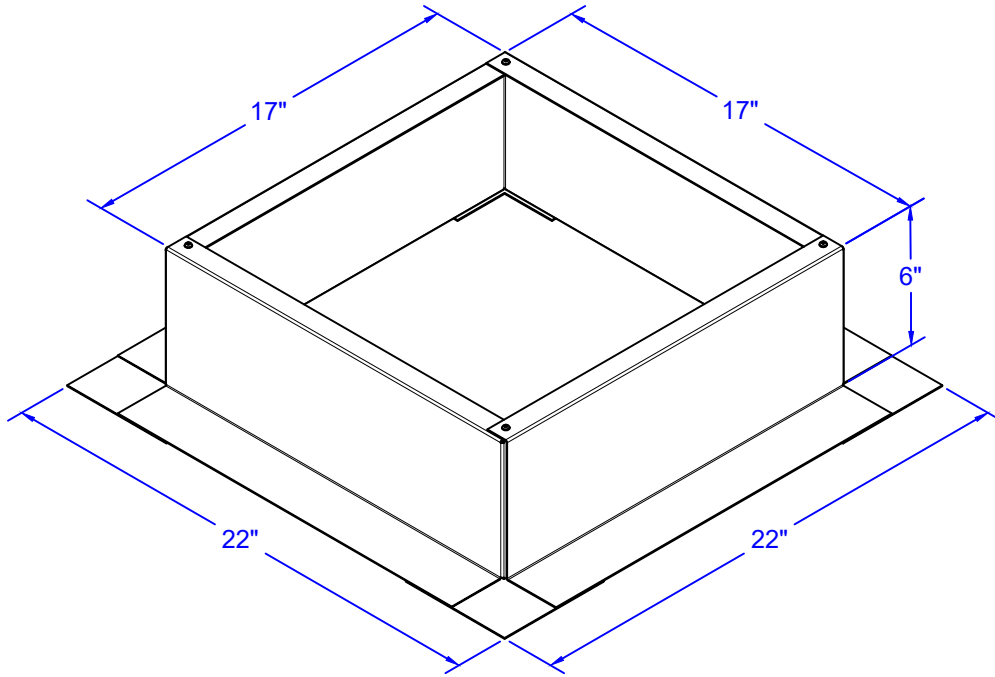

- Aluminum Alloy 3003-H14
- Thickness = 0.040" ± 0.005
- Tolerance = ± .25 (1/4")

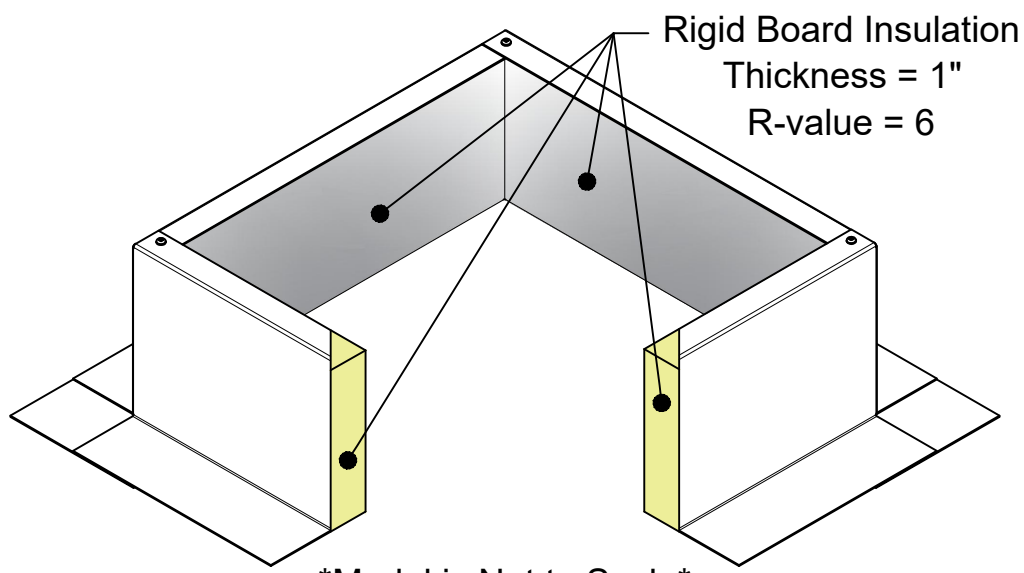
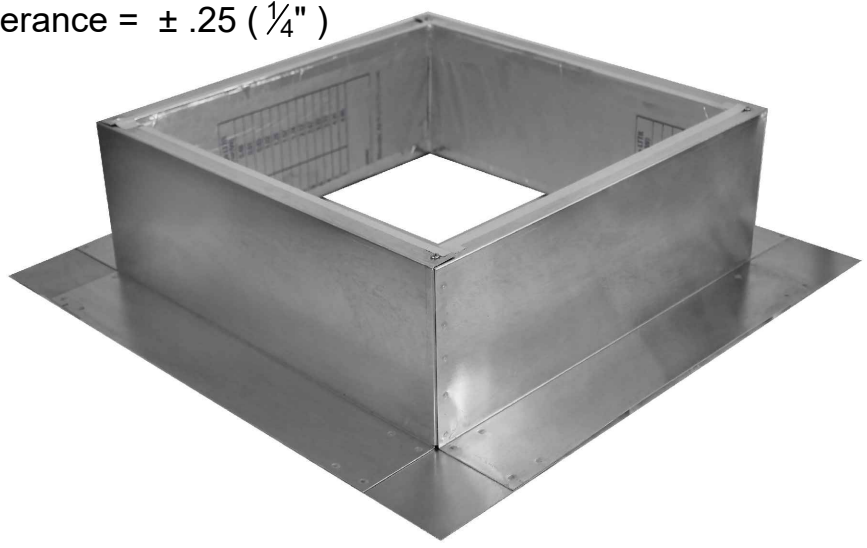

Model is Not to Scale