



Active Ventilation Products, Inc.

Website: roofvents.com

Email: sales@roofvents.com

Specification Sheet

1/1/2023

Insulated Roof Curb Model: RC-3-H12-Ins ID: 5" OD: 6"

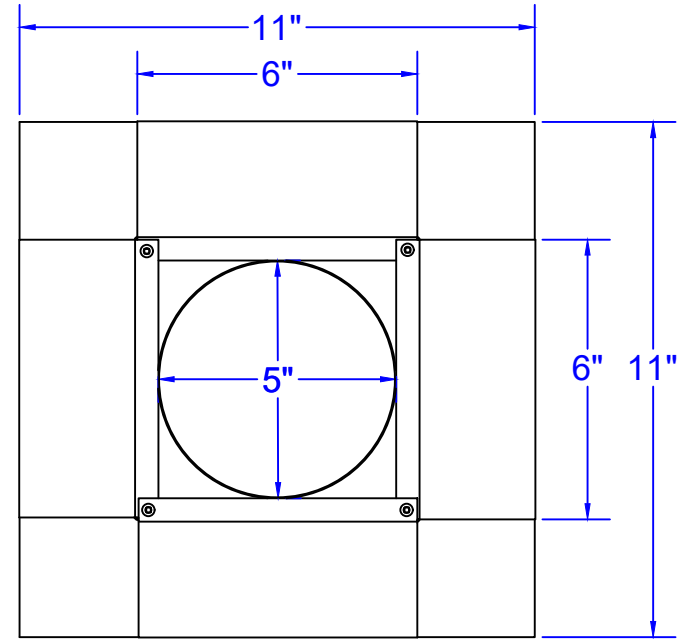
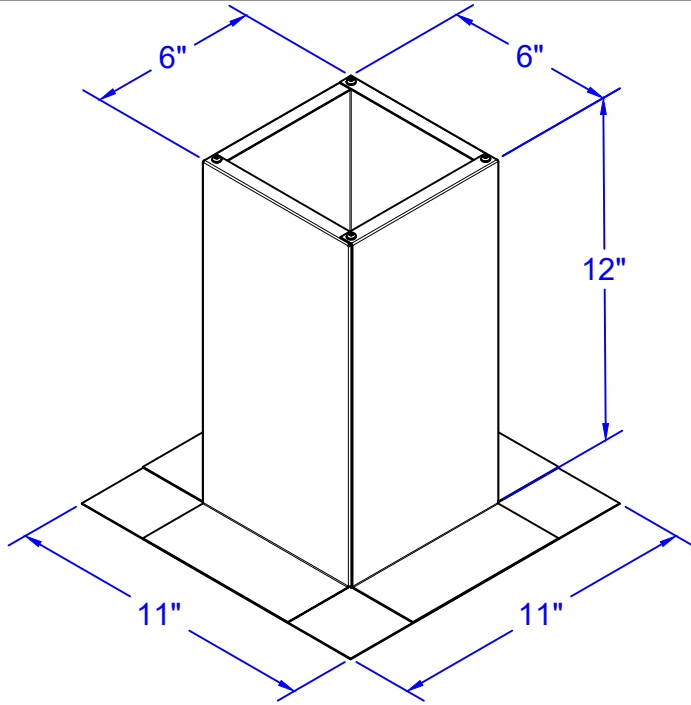

- Aluminum Alloy 3003-H14
- Thickness = $0.026" \pm 0.005$
- Tolerance = $\pm .25$ ($\frac{1}{4}"$)

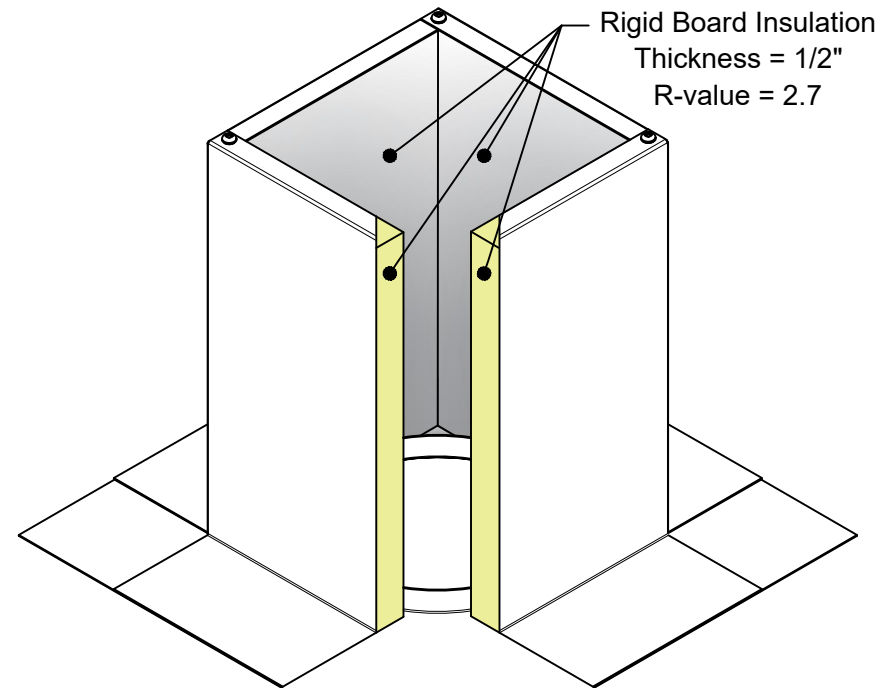

Model is Not to Scale