



Active Ventilation Products, Inc.

Website: roofvents.com

Email: sales@roofvents.com

Specification Sheet

9/6/2023

Insulated Roof Curb Model: RC-7-H8-Ins ID: 9" OD: 10"

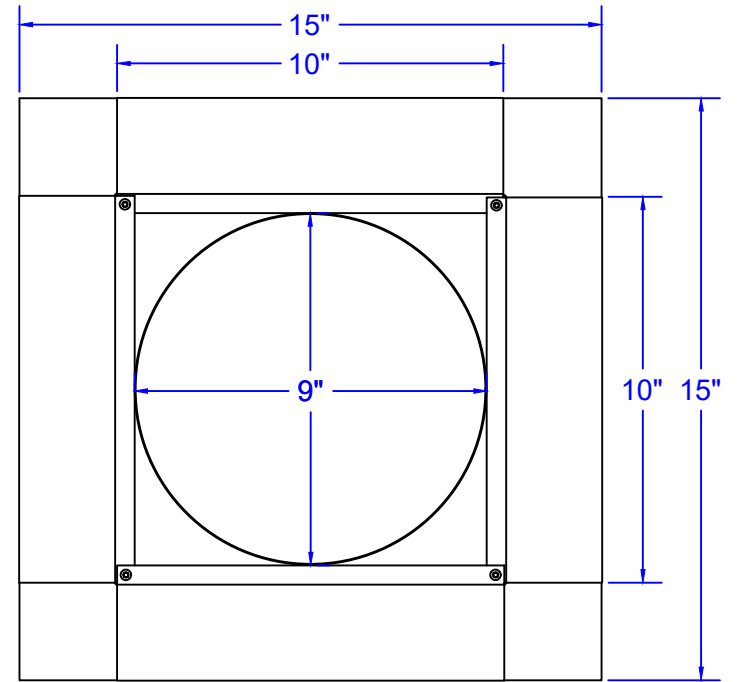
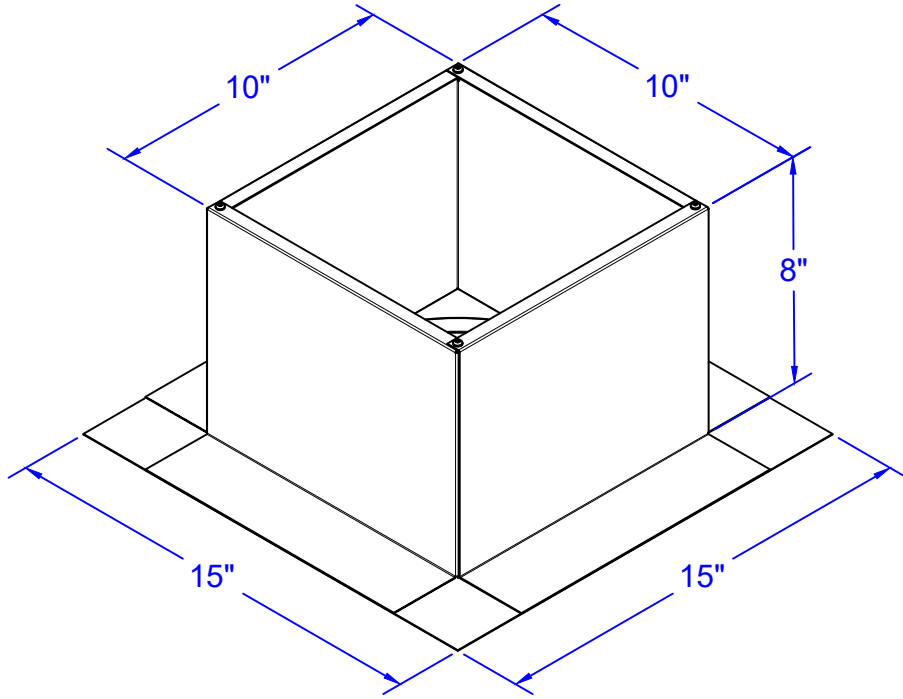

- Aluminum Alloy 3003-H14
- Thickness = 0.025" ± 0.005
- Tolerance = ± .25 (1/4")

