



# Active Ventilation Products, Inc.

Website: [roofvents.com](http://roofvents.com)

Email: [sales@roofvents.com](mailto:sales@roofvents.com)

# Specification Sheet

1/1/2023

Insulated Roof Curb Model: RC-8-H12-Ins ID: 10" OD: 11"

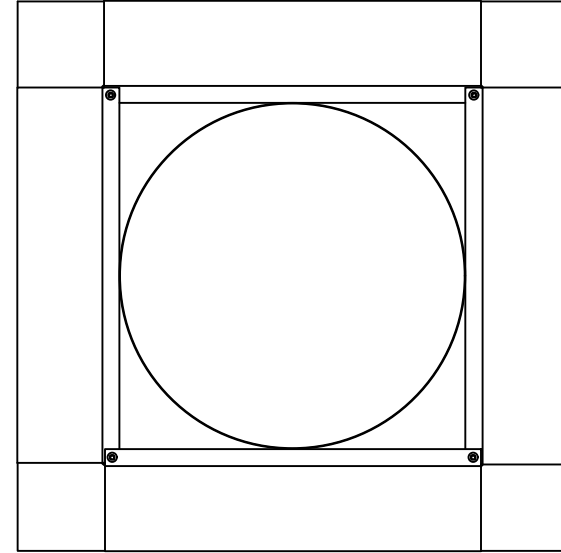
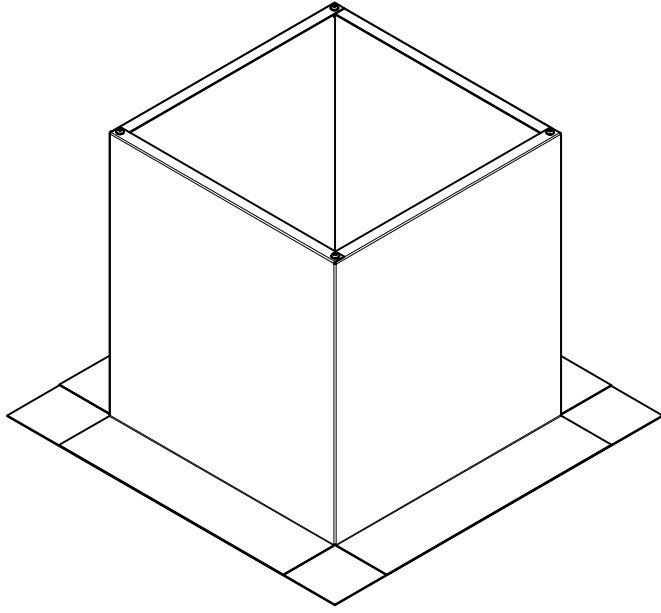

- Aluminum Alloy 3003-H14
- Thickness = 0.025" ± 0.005
- Tolerance = ± .25 ( 1/4" )

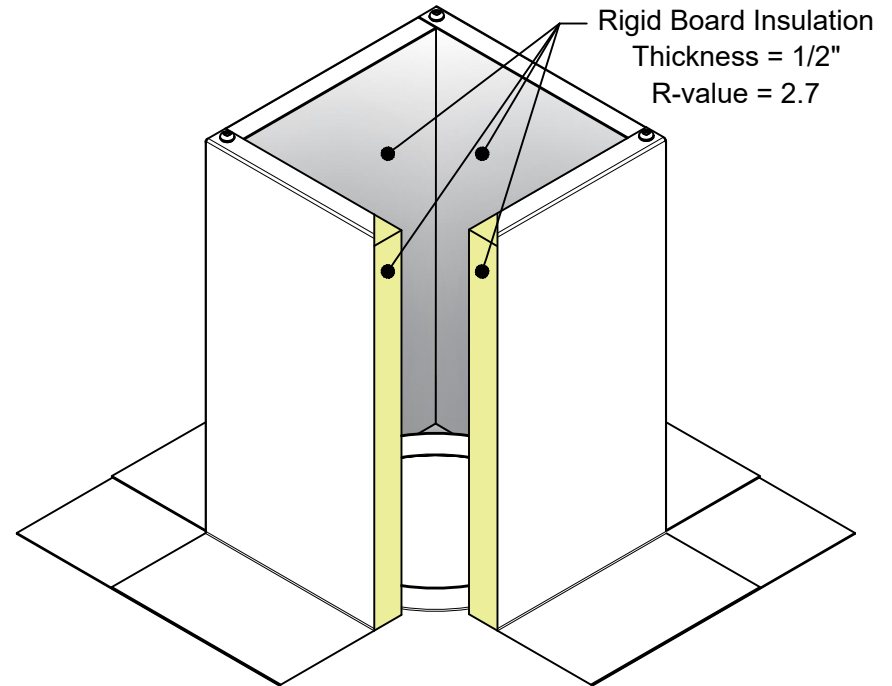

Rigid Board Insulation  
 Thickness = 1/2"  
 R-value = 2.7

\*Model is Not to Scale\*