

Installation Instructions for AV-12-C4-CMF

For EPDM, PVC or TPO Membrane Flat Roofs

Step 1:

For Roof Curb Installation see roofvents.com



Step 2:

Slide the Curb Mount Flange onto the roof curb.
Attach Curb Mount Flange to roof curb.

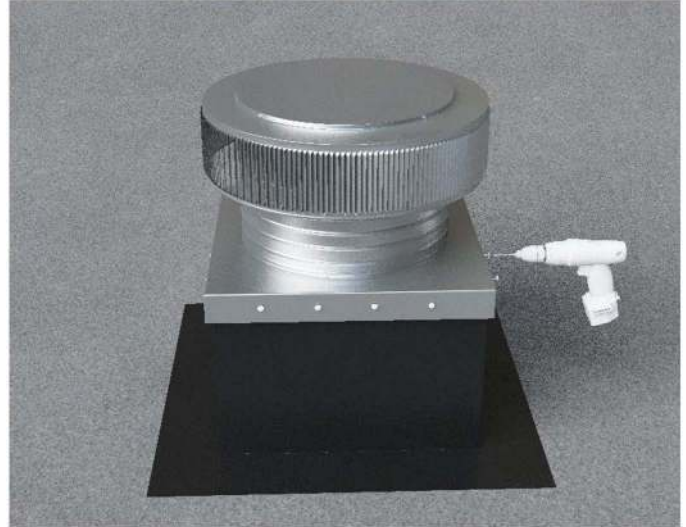

Step 3:

Required Screw: #8 x 1/2" hex washer head #2 point self drilling screw.

Total number of screws required = 16 (tolerance : 1/2")
see roofvents.com for a more detailed installation pattern.

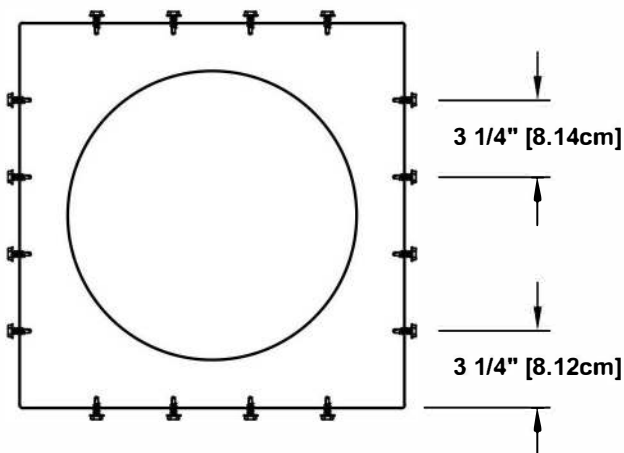

Roof Vent with Curb Mount Flange accessory
installed onto roof curb.

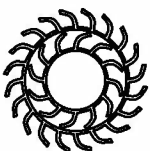
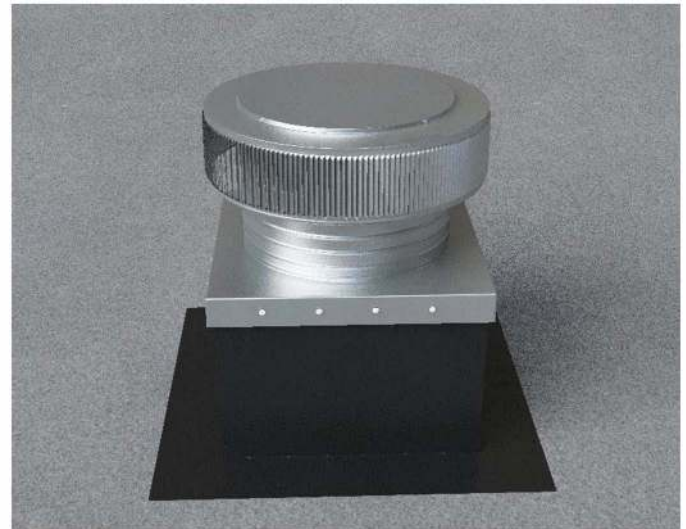

Active Ventilation Products, Inc.

311 First Street, Newburgh, NY 12550-4857

800-ROOF VENT (766-3836) Ph: 845-565-7770 Fax: 845-562-8963

Website: roofvents.com Email: sales@roofvents.com

5778-7