

Top View

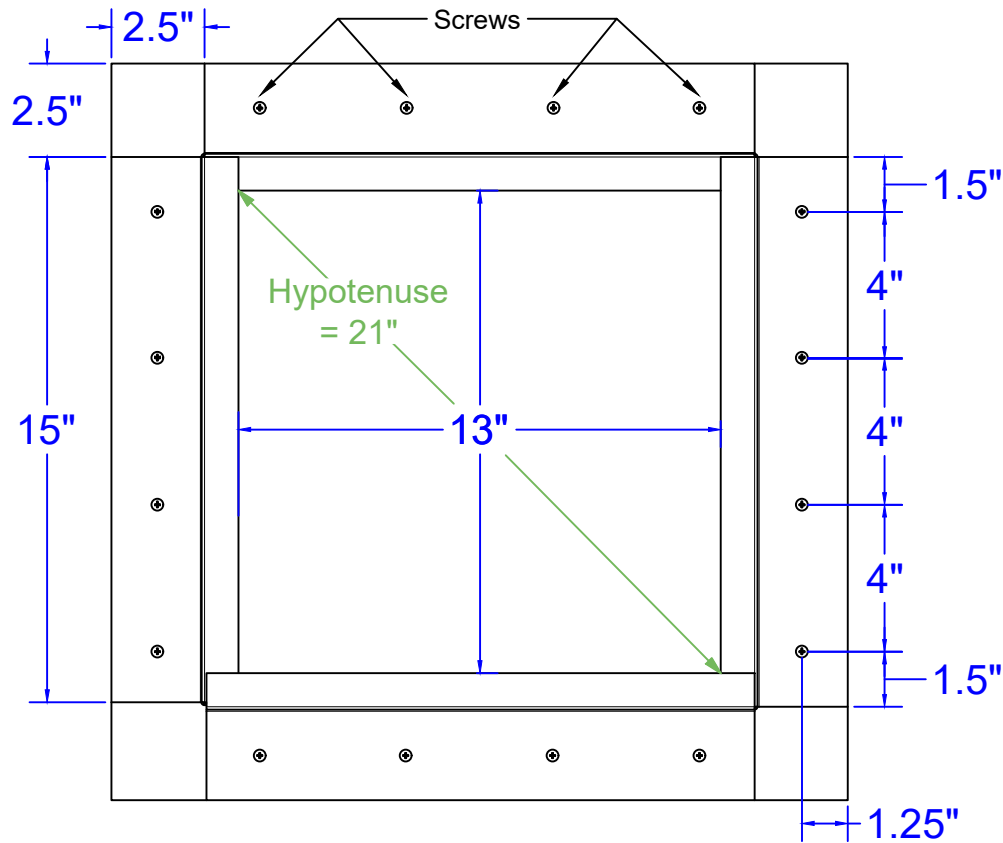

Roof Curb Flashing Detail

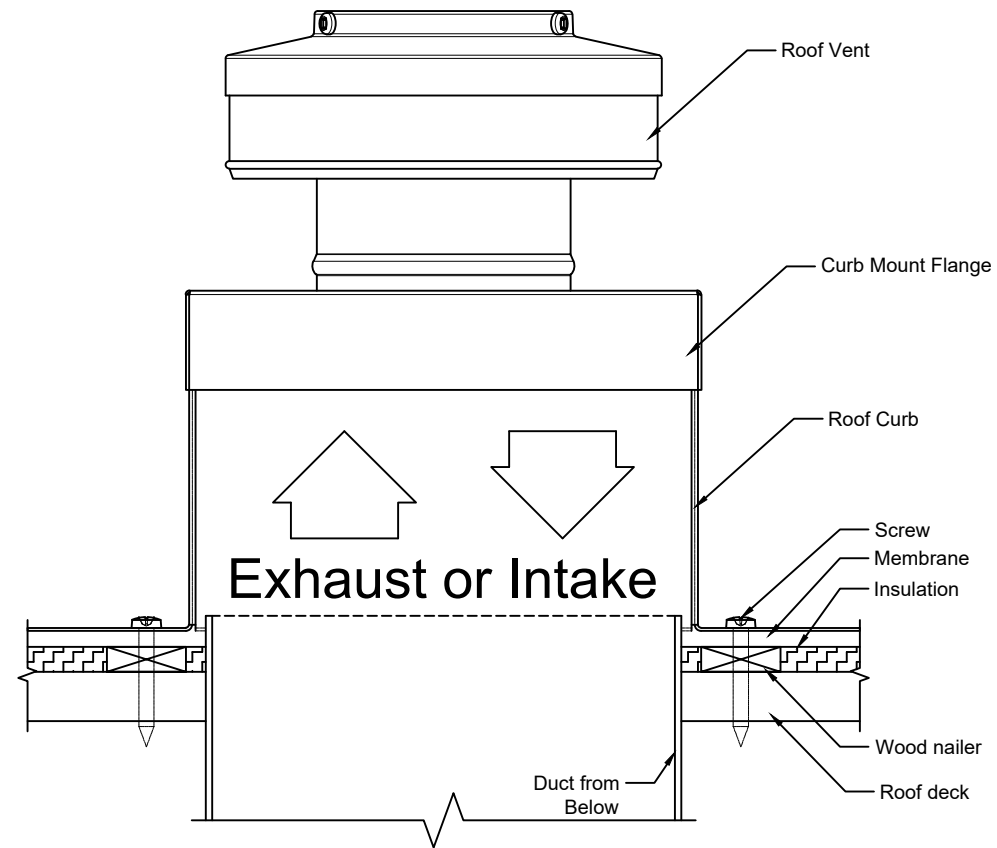

- Aluminum Alloy 3003-H14
- Thickness = 0.040" ± 0.005
- Tolerance = ± .25 (1/4")

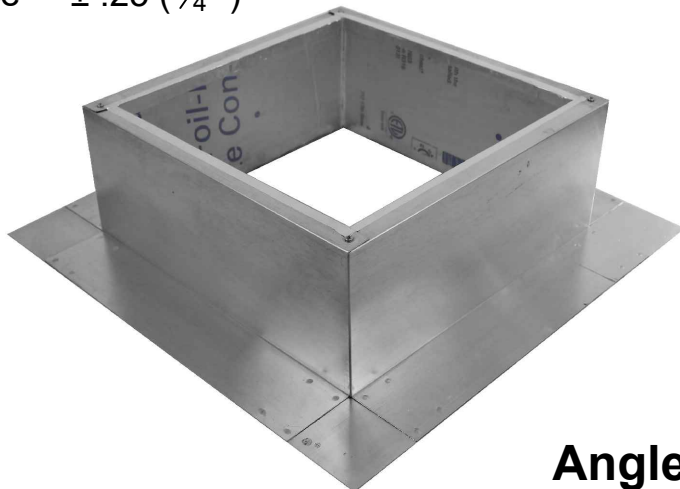

Angled View

Roof Curb Installation Instructions

1. Cut a square or round hole 17" in diameter in the roof deck.
2. Total number of screws needed for flange = 16
3. *Recommended installation screw: #10 x 1 1/2" Sheet Metal Screw*
4. Flash roof curb onto deck according to specifications of the membrane manufacturer.
5. Screws not included.

Insulated Roof Curb Model: RC-12-H6-Ins

Inside Opening: 13", Outside Length & Width: 15", Height: 6"

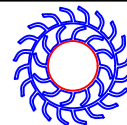

Active Ventilation Products, Inc.

Website: roofvents.com

Email: sales@roofvents.com

1/1/2023