

## Screw Pattern (Symmetrical for all sides)

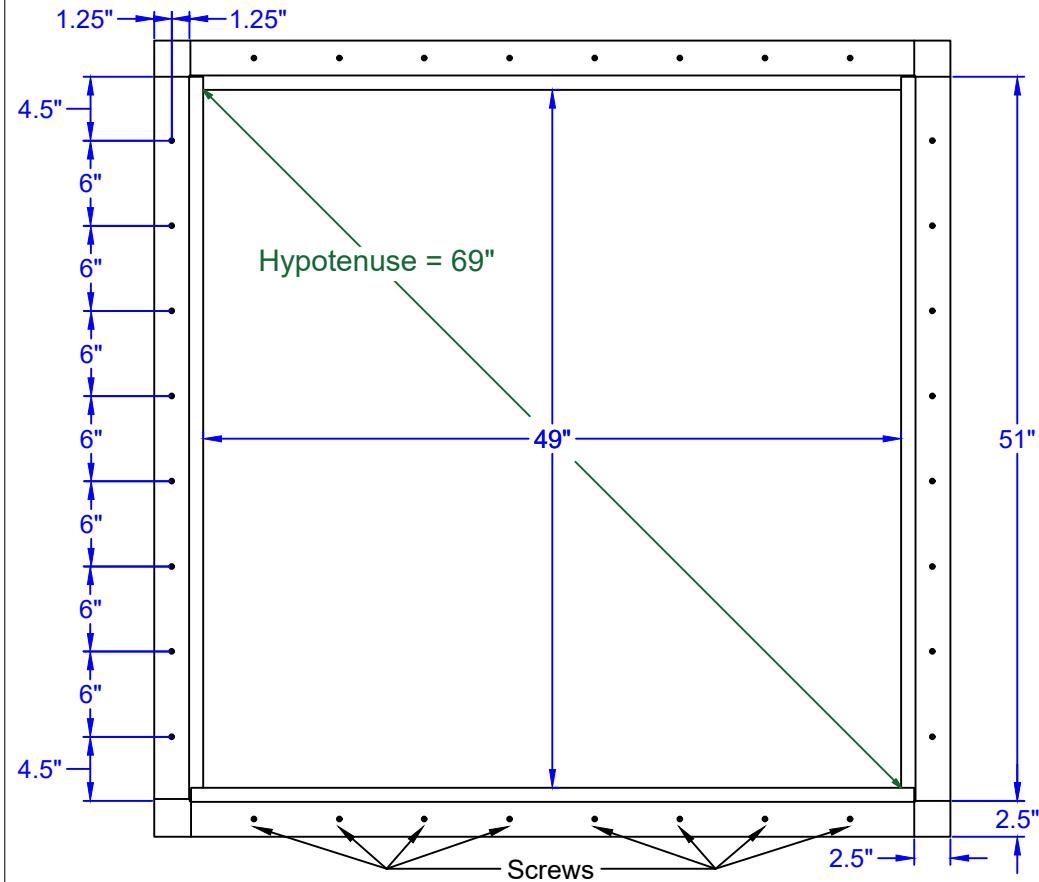

## Roof Curb Flashing Detail

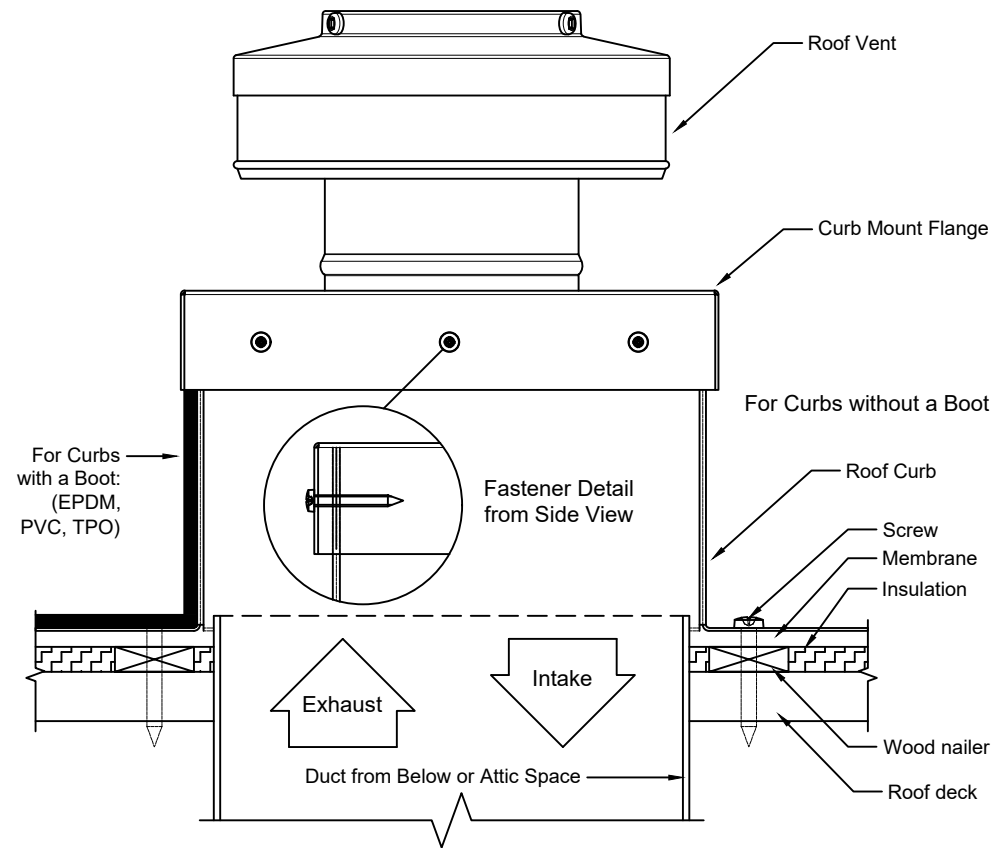

- Aluminum Alloy 3003-H14
- Thickness = 0.040" ± 0.005
- Tolerance = ± .25 ( 1/4" )



Angled View

## Roof Curb Installation Instructions

1. Cut a square or round hole 49" in diameter in the roof deck.
2. Total number of screws needed for flange = 32
3. *Recommended installation screw: Flat, Bugle or Wafer Head #10 x 1 1/2" Sheet Metal Screw, Type A Point*
4. Flash roof curb onto deck according to specifications of the membrane manufacturer.
5. Screws not included.

**Insulated Roof Curb Model: RC-48-H12-Ins**

Inside Opening: 49", Outside Length & Width: 51", Height: 12"

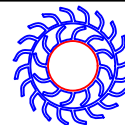

**Active Ventilation Products, Inc.**

Website: [roofvents.com](http://roofvents.com)

Email: [sales@roofvents.com](mailto:sales@roofvents.com)

11/17/2023