

## Top View

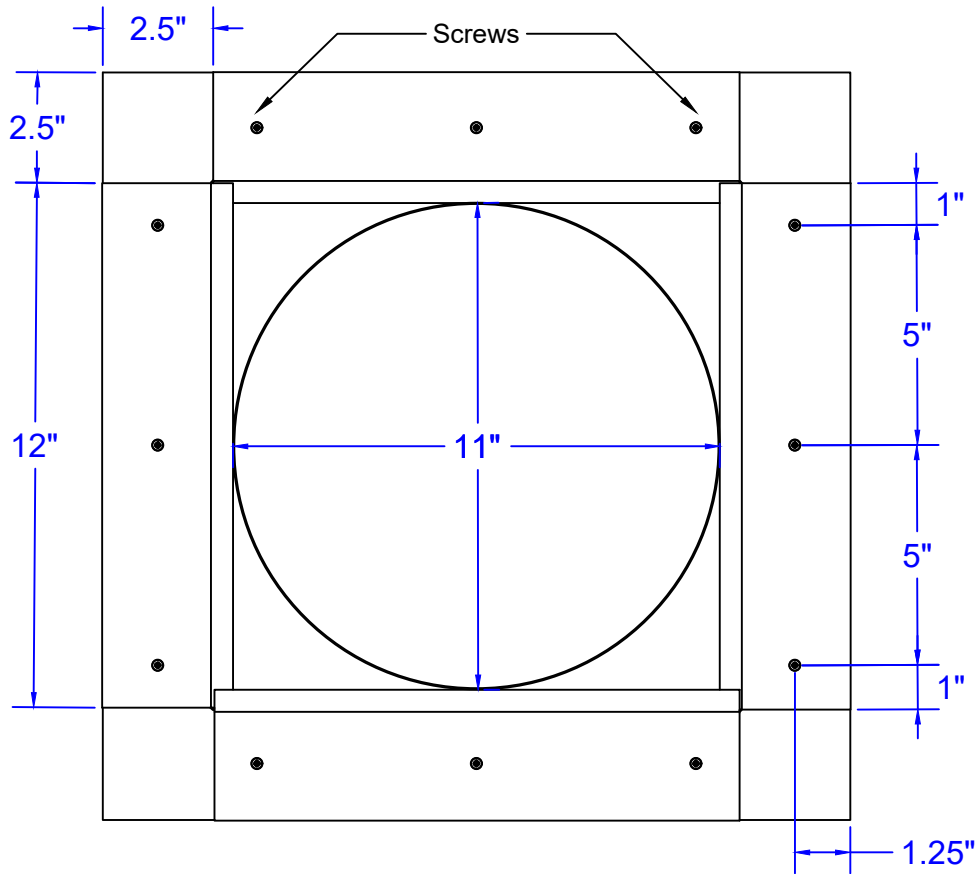

## Roof Curb Flashing Detail

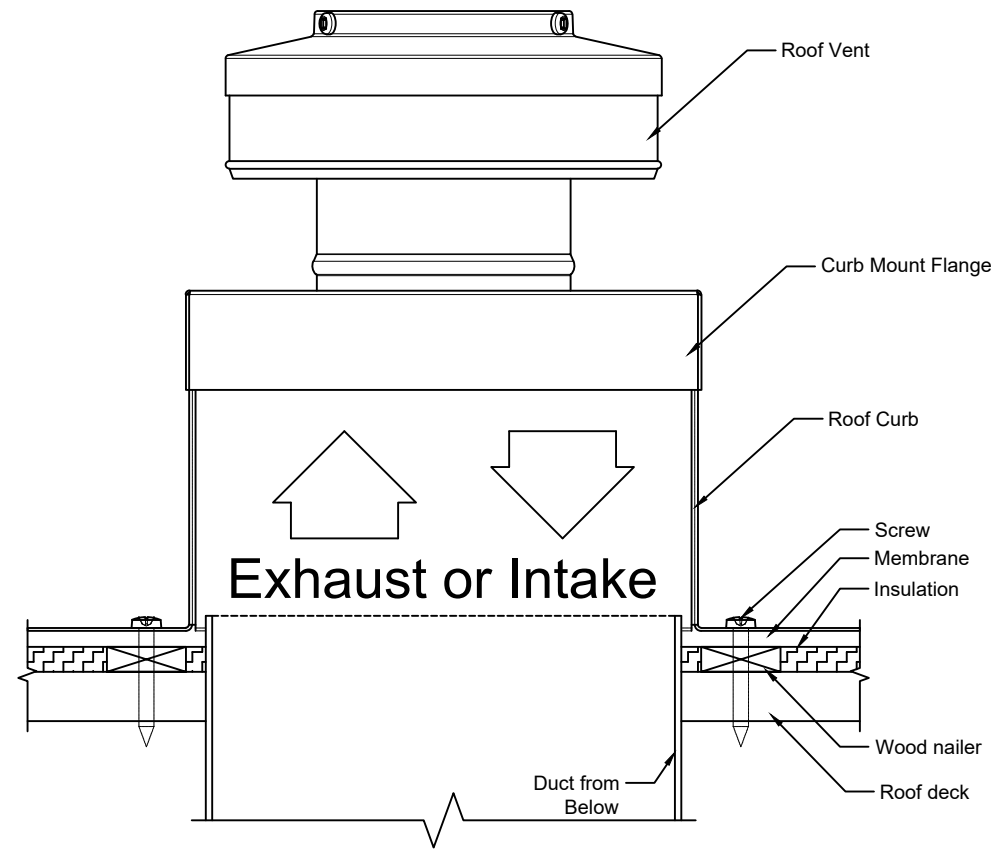

- Aluminum Alloy 3003-H14
- Thickness = 0.025" ± 0.005
- Tolerance = ± .25 ( 1/4" )



Angled View

## Roof Curb Installation Instructions

1. Cut a round hole 11" in diameter in the roof deck.
2. Total number of screws needed for flange = 12
3. *Recommended installation screw: #10 x 1 1/2" Sheet Metal Screw*
4. Flash roof curb onto deck according to specifications of the membrane manufacturer.
5. Screws not included.

### Roof Curb Model: RC-9-H12

Inside Opening: 11", Outside Length & Width: 12", Height: 12"

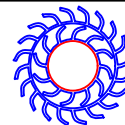

**Active Ventilation Products, Inc.**

Website: [roofvents.com](http://roofvents.com)

Email: [sales@roofvents.com](mailto:sales@roofvents.com)

1/1/2023