

## Top View

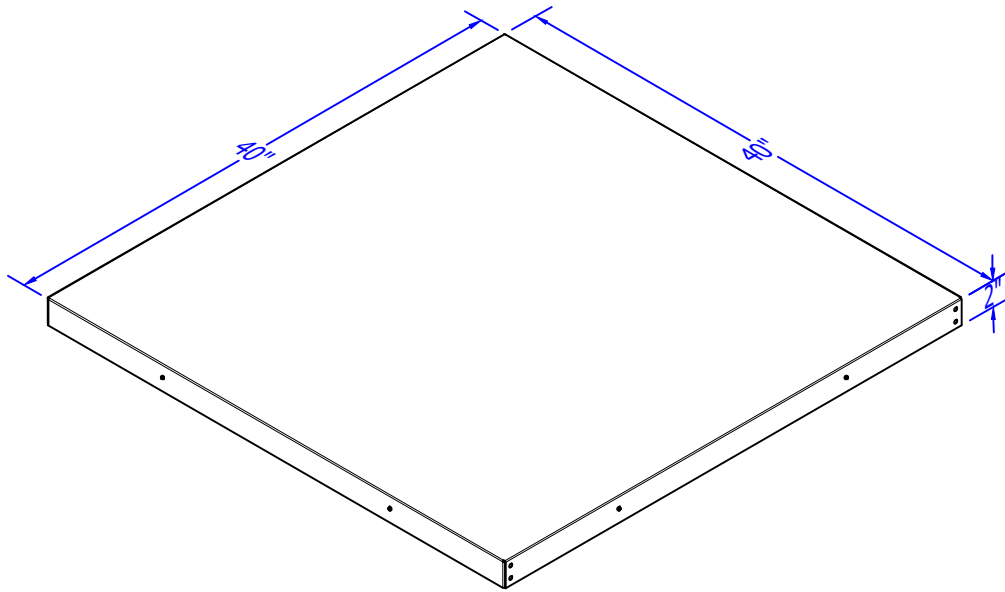

## Roof Curb Cap Flashing Detail

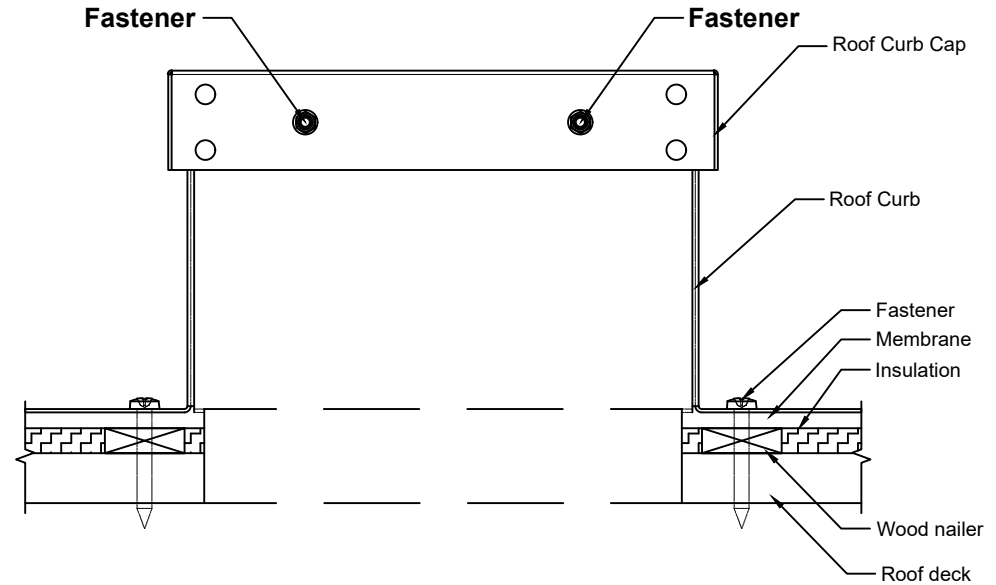

## Side View

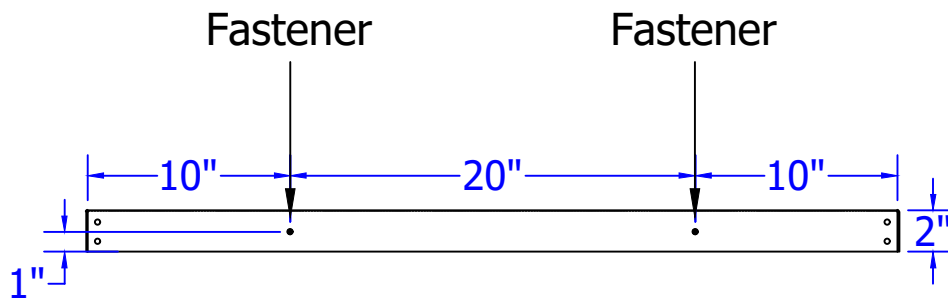

## Roof Curb Cap Installation Instructions

1. Optional: Place sealant over lip.
2. Center cap over roof curb.
3. Attach cap to roof curb using Self Tapping Sheet Metal Screw #8 x 1" on each side.
4. Total number of screws needed = 8

*Note: Screws and Roof curb not included.*

**Roof Curb Cap**

**Model: RC-Cap-36**

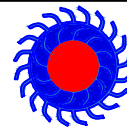

**Active Ventilation Products, Inc.**

Website: [roofvents.com](http://roofvents.com) Email: [sales@roofvents.com](mailto:sales@roofvents.com)

12/7/2021