

Curb Mount Flange Detail

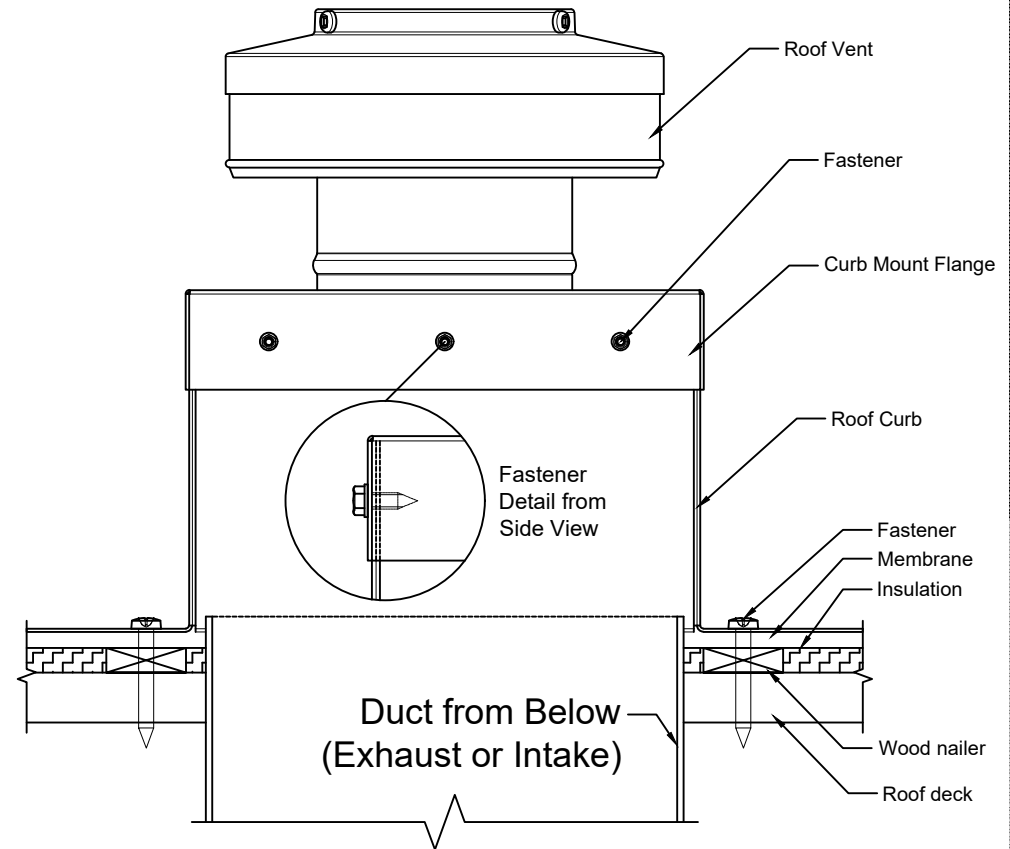

Curb Mount Flange Installation Instructions

1. Slide Curb Mount Flange onto the roof curb.
2. Attach Curb Mount Flange to roof curb using fasteners.
3. *Recommended installation screw: #8 x 1/2" Sheet Metal Screw*
4. Total number of screws needed for CMF = 12
5. Screws not included.

Round Back Vent with Curb Mount Flange

Model: RBV-5-C2-CMF

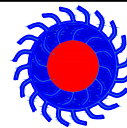

Active Ventilation Products, Inc.

Website: roofvents.com

Email: sales@roofvents.com

7/26/2022