

Angled View

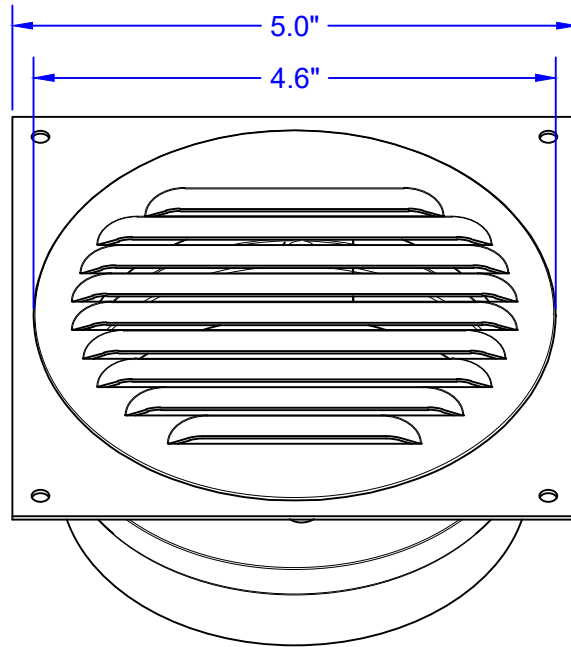

Side View

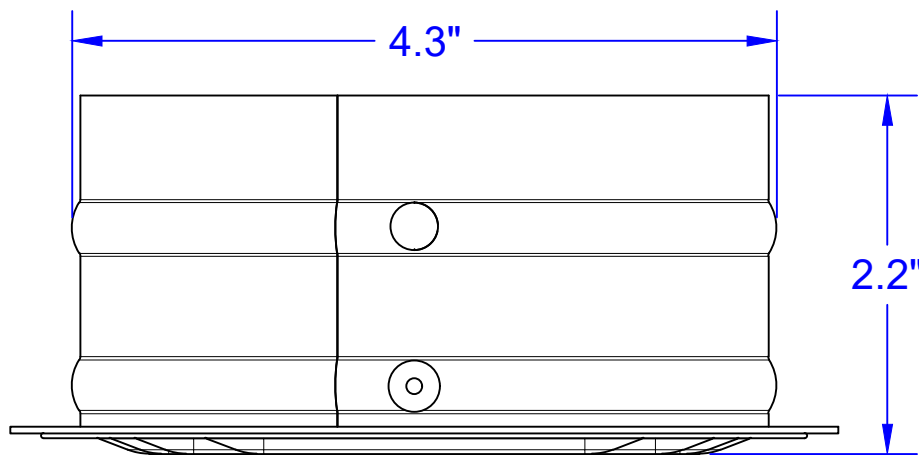

Bathroom Soffit Vent Flashing Detail & Installation Instructions

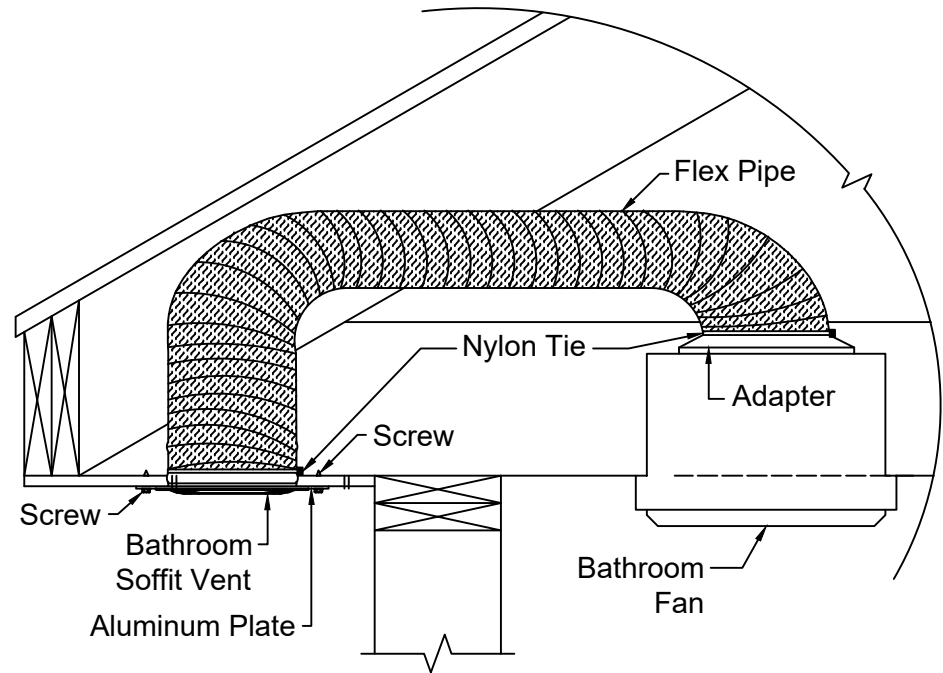

1. Cut a 4 1/4" hole into the soffit using a circular drill or jigsaw.
2. Run the flex pipe or semi rigid duct from the fan housing in the attic and push it through the hole that was cut in the soffit.
3. Attach the duct to the collar of the soffit vent using a nylon tie or adjustable clamp.
4. From outside of the home or building, push the duct and assembled unit back up through the hole. When you are done, the face plate of the louvers should be covering the hole of the soffit and lying flush.
5. Drill the aluminum face plate into the soffit using four screws to secure the soffit vent.
6. The other side of the duct in the attic should be attached to the fan housing adapter.
7. Recommended Screw: #8 x 1.0" Stainless Steel Sheet Metal Screw (Quantity: 4)