

Angled View

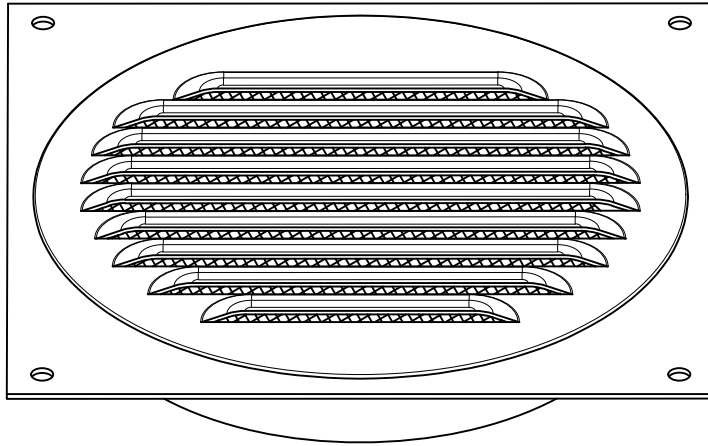

- Net Free Area (NFA) = 3.50 sq in

Side View

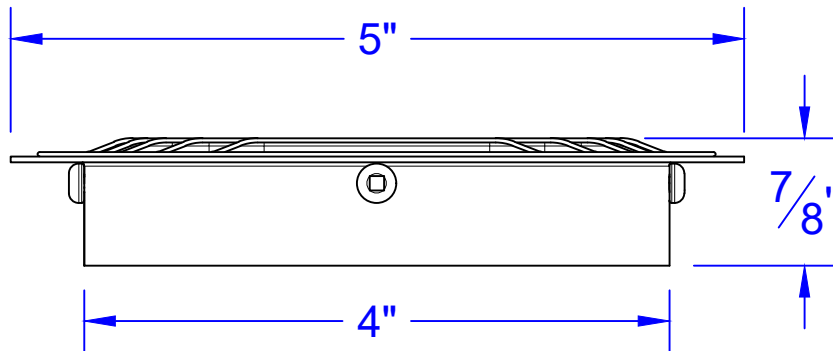

Round Soffit Vent Flashing Detail

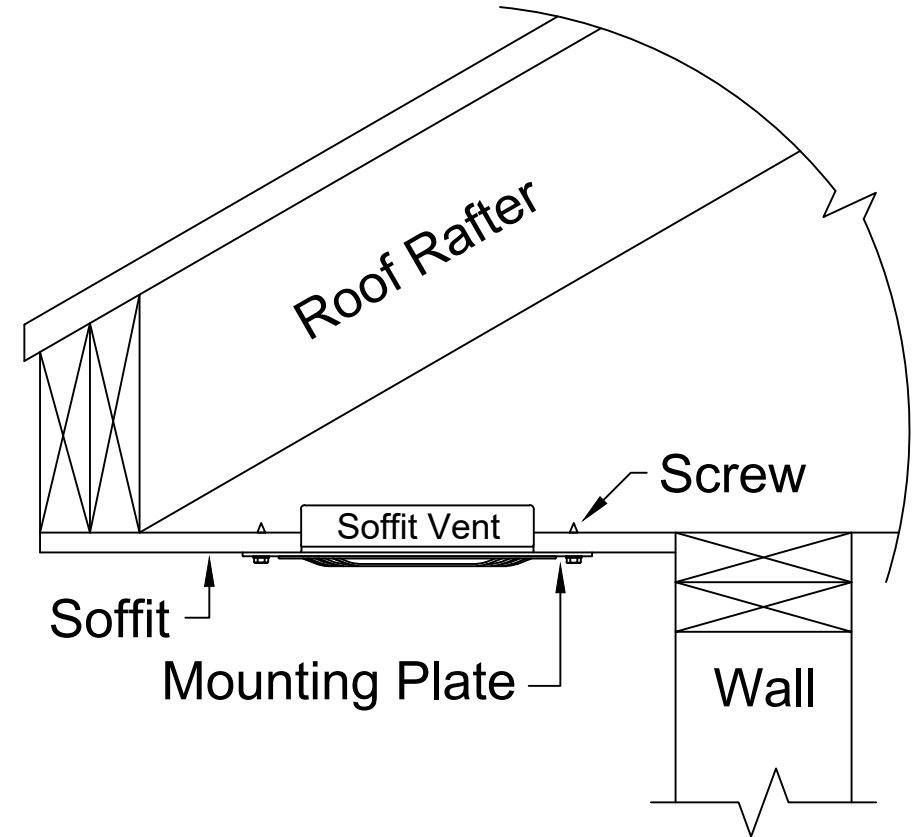

Round Soffit Vent Installation Instructions

1. Cut a 4" hole into the soffit using a hole saw.
2. Insert the vent into the hole in the soffit.
3. Attach the mounting plate onto the soffit using 4 screws to secure the soffit vent in place.

* Make sure the opening of the louvers are facing the house
** Recommended Screw: #8 x 1" Sheet Metal Screw (Screws not included)